

C A D E I N O R

SELECTCOLLECTION | An all time refined selection of our best made furniture.

FOLLOW US



www.cadeinor.com



6
–
xt94
–
xt
collection



14
–
xt91
–
xt
collection



22
–
xt82
–
xt
collection



28
–
xt81
–
xt
collection



34
–
xt74
–
xt
collection



44
–
xt71
–
xt
collection



50
–
xt54
–
xt
collection



56
–
xt51
–
xt
collection

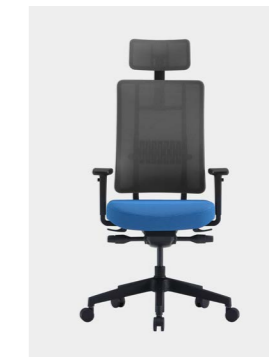

62
–
xt53
–
xt
collection

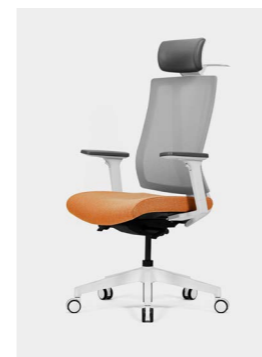

68
–
xt43
–
xt
collection



76
–
xt41
–
xt
collection



82
–
xt34
–
xt
collection

– index –



88
-
xt31
-
xt
collection



96
-
xt24
-
xt
collection



100
-
xt23
-
xt
collection



176
-
t-one
-
chairs



184
-
bounce
-
chairs



188
-
wave
-
chairs



106
-
york
-
chairs



132
-
**york
wood**
-
chairs



142
-
ark
-
chairs



192
-
rock
-
chairs



218
-
tommy
-
chairs



230
-
miza
-
chairs



148
-
hidra
-
chairs

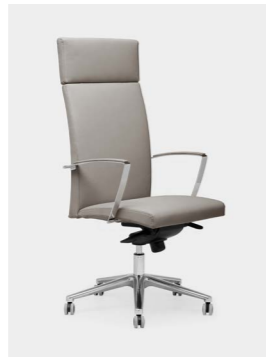

152
-
viva
-
chairs



156
-
d 60
-
chairs

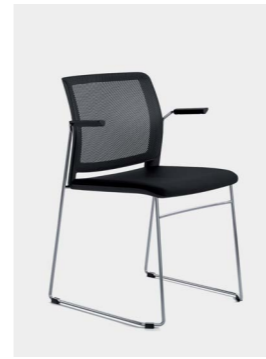

244
-
alpha
-
chairs



256
-
multy
-
chairs



266
-
dream
-
chairs



160
-
d 40
-
chairs



164
-
d 70
-
chairs



170
-
tron
-
chairs



274
-
**dream
plus**
-
chairs



278
-
nuke
-
chairs

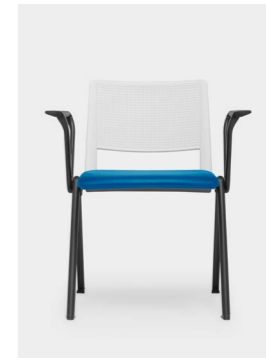

284
-
revo
-
chairs



288
–
nexus
–
soft seating



298
–
posh
–
soft seating



308
–
origem
–
soft seating

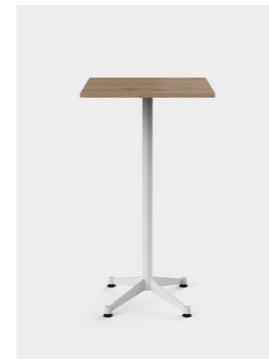

382
–
piton
–
tables



384
–
tavo
–
tables



386
–
power tab
–
tables



318
–
plug
–
soft seating



322
–
city
–
soft seating



332
–
donna
–
soft seating

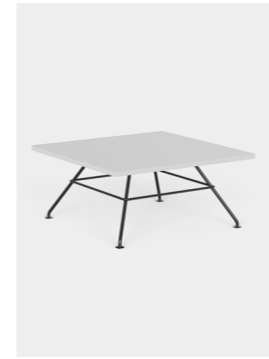

390
–
quadrata
–
tables



392
–
radius
–
tables



394
–
sharp
–
tables



338
–
quadrata
–
soft seating

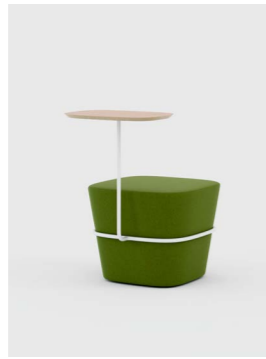

342
–
mush
–
soft seating



348
–
vinco
–
soft seating



396
–
tab 20
–
tables



400
–
grid
–
office systems



412
–
tab 60
–
office systems



352
–
wait xl
–
soft seating



358
–
wait xs
–
soft seating



366
–
mogly
–
chairs



XT94

Cada vez mais os produtos devem ter a capacidade de serem personalizados de acordo com as necessidades de cada cliente e espaço. Agora, com a possibilidade do revestimento da costa, a XT94 ganha personalidade através de mais texturas e combinações de cor.

Cada vez más, los productos deben poder personalizarse según las necesidades de cada cliente y espacio. Ahora, con la posibilidad de un revestimiento para el respaldo, el XT94 adquiere personalidad a través de más texturas y combinaciones de colores.

More than ever, products must be able to be customized to the needs of each customer and space. Now, with the possibility of coating the backrest, the XT94 gains personality through more textures and color combinations.

De plus en plus, les produits doivent pouvoir être adaptés aux besoins de chaque client et de chaque espace. Maintenant, avec la possibilité de couvrir le dos, le XT94 gagne en personnalité grâce à plus de textures et de combinaisons de couleurs.





XT94



XT COLLECTION



XT94

CADEINOR



CADEINOR



XT COLLECTION



XT94

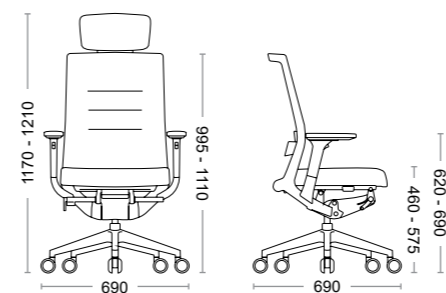

Características - Characteristics - Carácter - Fonctionnalités



Braços reguláveis 3D
3D adjustable armrests
Apoyabrazos regulables 3D
Accoudoirs ajustable 3D



Assento ajustável em profundidade
Adjustable depth seat
Asiento ajustable en profundidad
Siège réglable en profondeur



Apoio lombar flexível, altura ajustável
Flexible lumbar support, height adjustable
Apoyo lumbar flexible, altura ajustable
Support lombaire flexible, hauteur réglable

Corpo - Body - Cuerpo - Corps

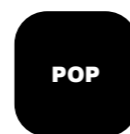

POP

Preto
Black
Negro
Noir

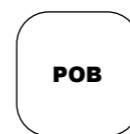

POB

Branco
White
Blanco
Blanc



XT91

A XT91 reflete toda a dedicação que é colocada no desenvolvimento de cada produto na Cadeinor. Uma cadeira com um equilíbrio entre a beleza das formas e a performance ergonómica.

La XT91 refleja toda la dedicación que se coloca en el desarrollo de cada producto en Cadeinor. Una silla con un equilibrio entre la belleza de las formas y el rendimiento ergonómico.

The XT91 reflects all the dedication that is put into the development of each product at Cadeinor. A chair with a balance between beauty of shapes and ergonomic performance.

La XT91 reflète tout le dévouement qui va dans le développement de chaque produit dans Cadeinor. Une chaise avec un équilibre entre la beauté des formes et la performance ergonomique.









XT91

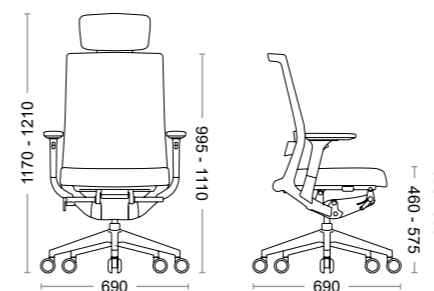

Características - Characteristics - Carácter - Fonctionnalités



Braços reguláveis 3D
3D adjustable armrests
Apoyabrazos regulables 3D
Accoudoirs ajustable 3D



Assento ajustável em profundidade
Adjustable depth seat
Asiento ajustable en profundidad
Siège réglable en profondeur



Apoio lombar flexível, altura ajustável
Flexible lumbar support, height adjustable
Apoyo lumbar flexible, altura ajustable
Support lombaire flexible, hauteur réglable

Corpo - Body - Cuerpo - Corps

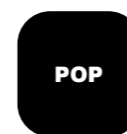

POP

Preto
Black
Negro
Noir



POB

Branco
White
Blanco
Blanc



XT82

A XT82 foi concebida para proporcionar máximo suporte, flexibilidade e eficiência, utilizando a mais recente tecnologia. O design inovador é caracterizado pelo foco na ergonomia e altos padrões de qualidade, aliados a uma estética sofisticada e descontraída.

La XT82 fue pensada para proporcionar el máximo soporte, flexibilidad y eficiencia, utilizando la última tecnología. El diseño innovador se caracteriza por un enfoque en la ergonomía y altos estándares de calidad, combinados con una estética sofisticada y relajada.

XT82 has being conceived to provide maximum support, controlled flexibility and optimum efficiency by utilizing the ultimate technology and control purposes. The innovative design is characterized by a focus on ergonomics, high quality standards and a sophisticated aesthetic appeal.

La chaise XT82 est conçu pour fournir un soutien maximal, flexibilité et efficacité en utilisant la plus récente technologie. La conception innovante est caractérisé par l'accent sur l'ergonomie et des normes élevées de qualité, allié à une esthétique sophistiquée et décontractée.





XT82

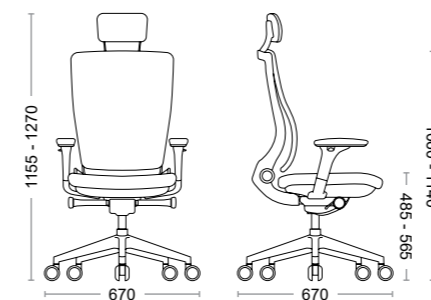

Características - Characteristics - Carácter - Fonctionnalités



Braços reguláveis 2D/ 3D
2D/ 3D adjustable armrests
Apoyabrazos regulables 2D/ 3D
Accoudoirs ajustable 2D/ 3D



Assento ajustável em profundidade
Adjustable depth seat
Asiento ajustable en profundidad
Siège réglable en profondeur

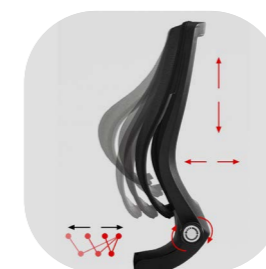

Apoio lombar ajustável, Fit System
Fit System adjustable lumbar support
Apoyo lumbar regulable Fit System
Appui lombaire ajustable Fit System

Corpo - Body - Cuerpo - Corps



Preto
Black
Negro
Noir

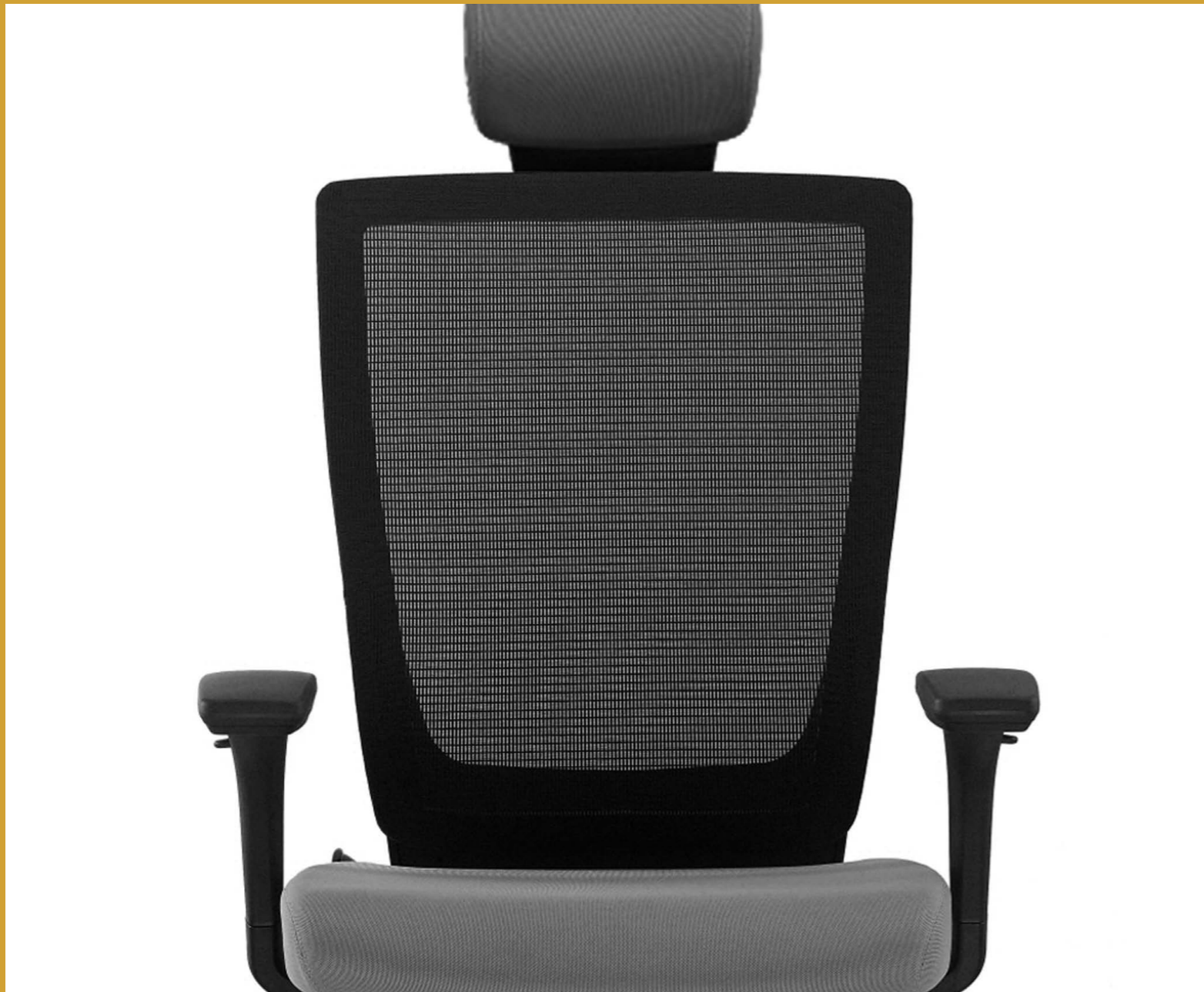

XT81

Cada pessoa tem uma postura única e transitória, para essas pessoas existe a XT81. Um modelo dinâmico que acompanha os movimentos do utilizador e que o incentiva a adotar uma postura correta, melhorando assim o desempenho no trabalho.

Cada persona tiene una postura única y transitoria, para ellas existe la XT81. Un modelo dinámico que sigue los movimientos del usuario y que incentiva a adoptar una postura correcta, mejorando así su desempeño en el trabajo.

Everyone has a different and variable spinal shape, and for those we have the XT81. A dynamic chair that follows the user's movements encourages a good posture and improves your performance at work.

Chaque personne a une posture unique et transitoire, pour ces gens il existe la chaise XT81. Un modèle dynamique qui accompagne les mouvement de l'utilisateur et qui l'encourage à adopter une posture correcte.





XT81

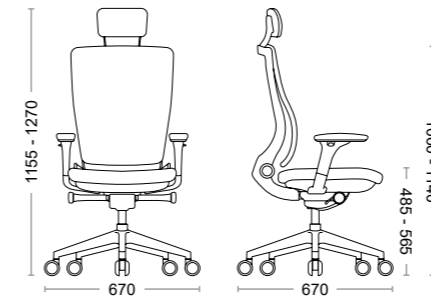

Características - Characteristics - Carácter - Fonctionnalités



Braços reguláveis 2D/ 3D
2D/ 3D adjustable armrests
Apoyabrazos regulables 2D/ 3D
Accoudoirs ajustable 2D/ 3D



Assento ajustável em profundidade
Adjustable depth seat
Asiento ajustable en profundidad
Siège réglable en profondeur

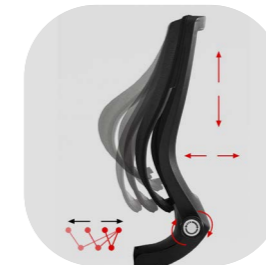

Apoio lombar ajustável, Fit System
Fit System adjustable lumbar support
Apoyo lumbar regulable Fit System
Appui lombaire ajustable Fit System

Corpo - Body - Cuerpo - Corps

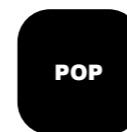

Preto
Black
Negro
Noir



XT74

Cada vez mais os produtos devem ter a capacidade de serem personalizados de acordo com as necessidades de cada cliente e espaço. Agora, com a possibilidade do revestimento da costa, a XT74 ganha personalidade através de mais texturas e combinações de cor.

Cada vez más, los productos deben poder personalizarse según las necesidades de cada cliente y espacio. Ahora, con la posibilidad de un revestimiento para el respaldo, el XT74 adquiere personalidad a través de más texturas y combinaciones de colores.

More than ever, products must be able to be customized to the needs of each customer and space. Now, with the possibility of coating the backrest, the XT74 gains personality through more textures and color combinations.

De plus en plus, les produits doivent pouvoir être adaptés aux besoins de chaque client et de chaque espace. Maintenant, avec la possibilité de couvrir le dos, le XT74 gagne en personnalité grâce à plus de textures et de combinaisons de couleurs.











XT74

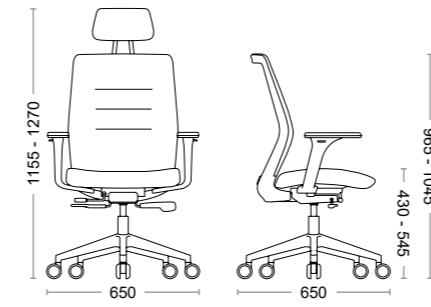

Características - Characteristics - Carácter - Fonctionnalités



Braços reguláveis 2D (Preto) / 3D 2D (Black) / 3D adjustable armrests / Apoyabrazos regulables 2D (Negro) / 3D Accoudoirs ajustable 2D (Noir) / 3D



Assento ajustável em profundidade / Adjustable depth seat / Asiento ajustable en profundidad / Siège réglable en profondeur

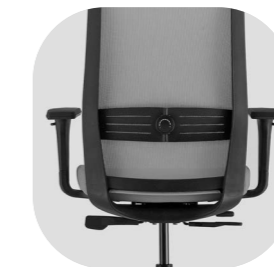

Apoio lombar regulável em profundidade / Depth adjustable lumbar support / Soporte lumbar regulable en profundidad / Soutien lombaire ajustable en profondeur

Corpo - Body - Cuerpo - Corps



POP

Preto
Black
Negro
Noir



POB

Branco
White
Blanco
Blanc



XT71

A linha XT é facilmente associada à identidade da Cadeinor. O modelo XT71 é um dos mais recentes, reforçando e, acima de tudo, melhorando a oferta nesse sentido. Uma cadeira plena de personalidade ideal para o espaço de trabalho.

La línea XT se asocia fácilmente a la identidad de la Cadeinor. El modelo XT71 es de los más actuales, reforzando y, sobre todo, mejorando la oferta en ese sentido. Una silla llena de personalidad ideal para el espacio de trabajo.

The XT collection is easily associated with Cadeinor's identity. The XT71 model is one of the most recent, reinforcing and, above all, improving our offer range. A working chair full of personality, ideal for the workspace.

La collection XT est facilement associée à l'identité de Cadeinor. Le modèle est l'un des plus récents, renforçant, surtout, améliorer notre gamme d'offre. Une chaise de travail pleine de personnalité, idéal pour l'espace de travail.







XT71

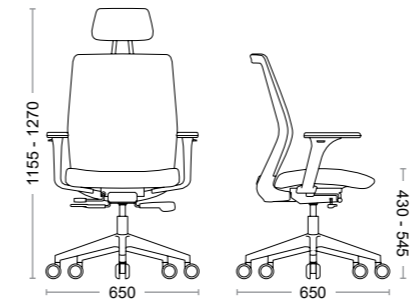

Características - Characteristics - Carácter - Fonctionnalités



Braços reguláveis 2D (Preto) / 3D 2D (Black) / 3D adjustable armrests
Apoyabrazos regulables 2D (Negro) / 3D Accoudoirs ajustable 2D (Noir) / 3D



Assento ajustável em profundidade
Adjustable depth seat
Asiento ajustable en profundidad
Siege réglable en profondeur

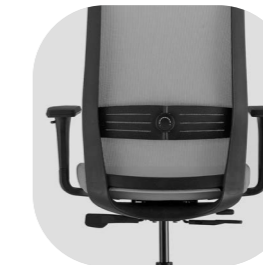

Apoio lombar regulável em profundidade
Depth adjustable lumbar support
Soporte lumbar regulable en profundidad
Soutien lombaire ajustable en profondeur

Corpo - Body - Cuerpo - Corps

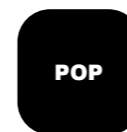

POP

Preto
Black
Negro
Noir



POB

Branco
White
Blanco
Blanc



XT54

Uma cadeira moderna e ergonómica com sistema de bloqueio multi-posicional e regulador de tensão. O assento ajustável em profundidade e apoio lombar proporciona uma postura mais correta e saudável.

Una silla moderna y ergonómica con sistema de fijación multiposicional y regulador de tensión. El asiento ajustable en profundidad y el apoyo lumbar, proporcionan una postura más correcta y saludable.

The modern ergonomic chair features with multi position locking system and tilt tension. The depth adjustable seat brings a better body back support and healthy posture.

Une chaise moderne et ergonomique avec un système de blocage multi positionnel et régulateur de tension. Le siège ajustable en profondeur et l'appui lombaire proportionne une posture plus correcte et saine.



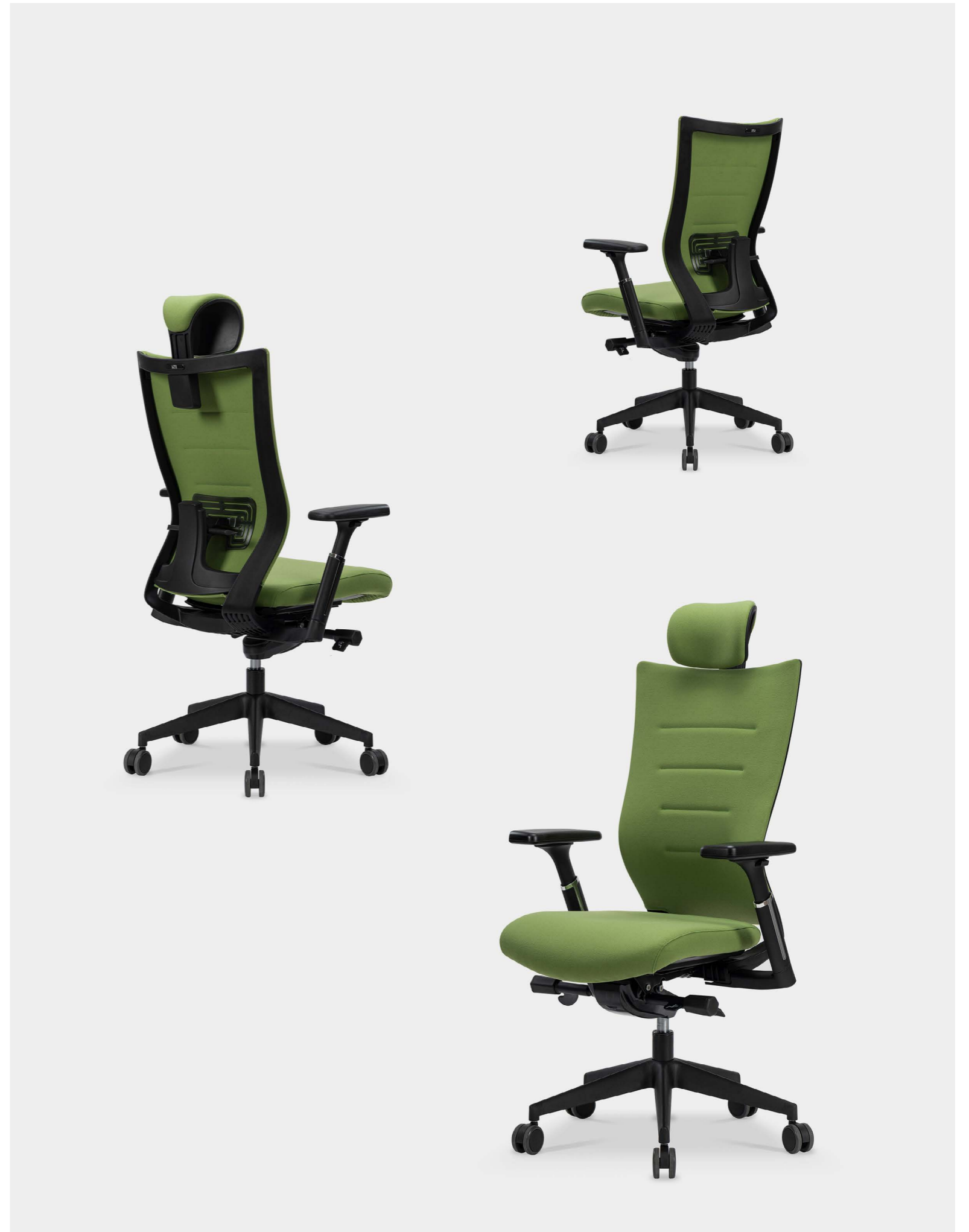

XT54

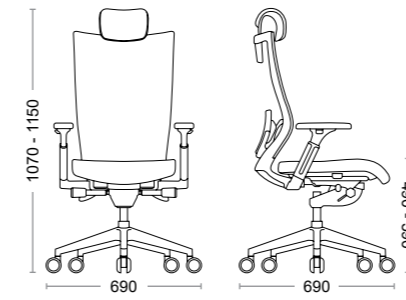

Características - Characteristics - Carácter - Fonctionnalités



Braços reguláveis 3D
3D adjustable armrests
Apoyabrazos regulables 3D
Accoudoirs ajustable 3D



Assento ajustável em profundidade
Adjustable depth seat
Asiento ajustable en profundidad
Siège réglable en profondeur



Apoio lombar regulável em profundidade
Depth adjustable lumbar support
Soporte lumbar regulable en profundidad
Soutien lombaire ajustable en profondeur

Corpo - Body - Cuerpo - Corps

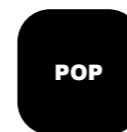

Preto
Black
Negro
Noir



XT51

Uma cadeira moderna e ergonómica com sistema de bloqueio multi-posicional e regulador de tensão. O assento ajustável em profundidade e apoio lombar proporciona uma postura mais correta e saudável.

Una silla moderna y ergonómica con sistema de fijación multiposicional y regulador de tensión. El asiento ajustable en profundidad y el apoyo lumbar, proporcionan una postura más correcta y saludable.

The modern ergonomic chair features with multi position locking system and tilt tension. The depth adjustable seat brings a better body back support and healthy posture.

Une chaise moderne et ergonomique avec un système de blocage multi positionnel et régulateur de tension. Le siège ajustable en profondeur et l'appui lombaire proportionne une posture plus correcte et saine.





XT51



XT51

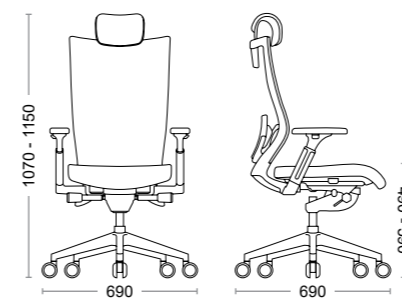

Características - Characteristics - Carácter - Fonctionnalités



Braços reguláveis 3D
3D adjustable armrests
Apoyabrazos regulables 3D
Accoudoirs ajustable 3D



Assento ajustável em profundidade
Adjustable depth seat
Asiento ajustable en profundidad
Siège réglable en profondeur



Apoio lombar regulável em profundidade
Depth adjustable lumbar support
Soporte lumbar regulable en profundidad
Soutien lombaire ajustable en profondeur

Corpo - Body - Cuerpo - Corps

POP

Preto
Black
Negro
Noir



XT53

Como é típico em toda a coleção XT, a nossa 53 não foge à regra, sendo mais um exemplo de conforto e bem-estar. Com mecanismos visualmente apelativos, e uma forma mais orgânica que o habitual.

Como es típico en toda la colección XT, nuestra 53 no es una excepción, sino que es otro ejemplo de comodidad y bienestar. Con mecanismos visualmente atractivos y una forma más orgánica de lo habitual.

As is typical throughout the XT collection, our 53 is no exception, being another example of comfort and well-being. With visually appealing mechanisms, and a more organic shape than usual.

Comme il est typique dans la collection XT, notre 53 ne fait pas exception, constitue un autre exemple de confort et de bien-être. Avec des mécanismes visuellement attrayants et une forme plus organique que d'habitude.



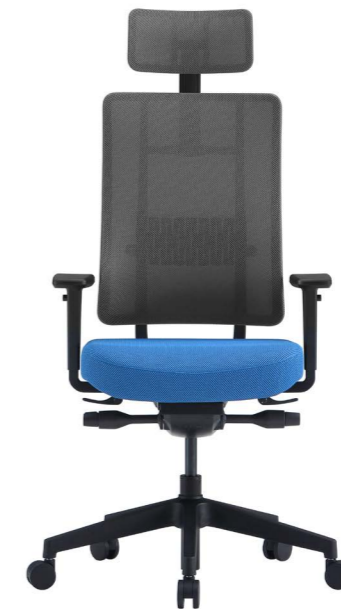



XT53

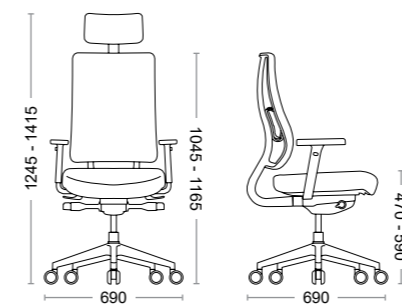

Corpo - Body - Cuerpo - Corps

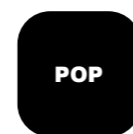

POP

Preto
Black
Negro
Noir



POB

Branco
White
Blanco
Blanc

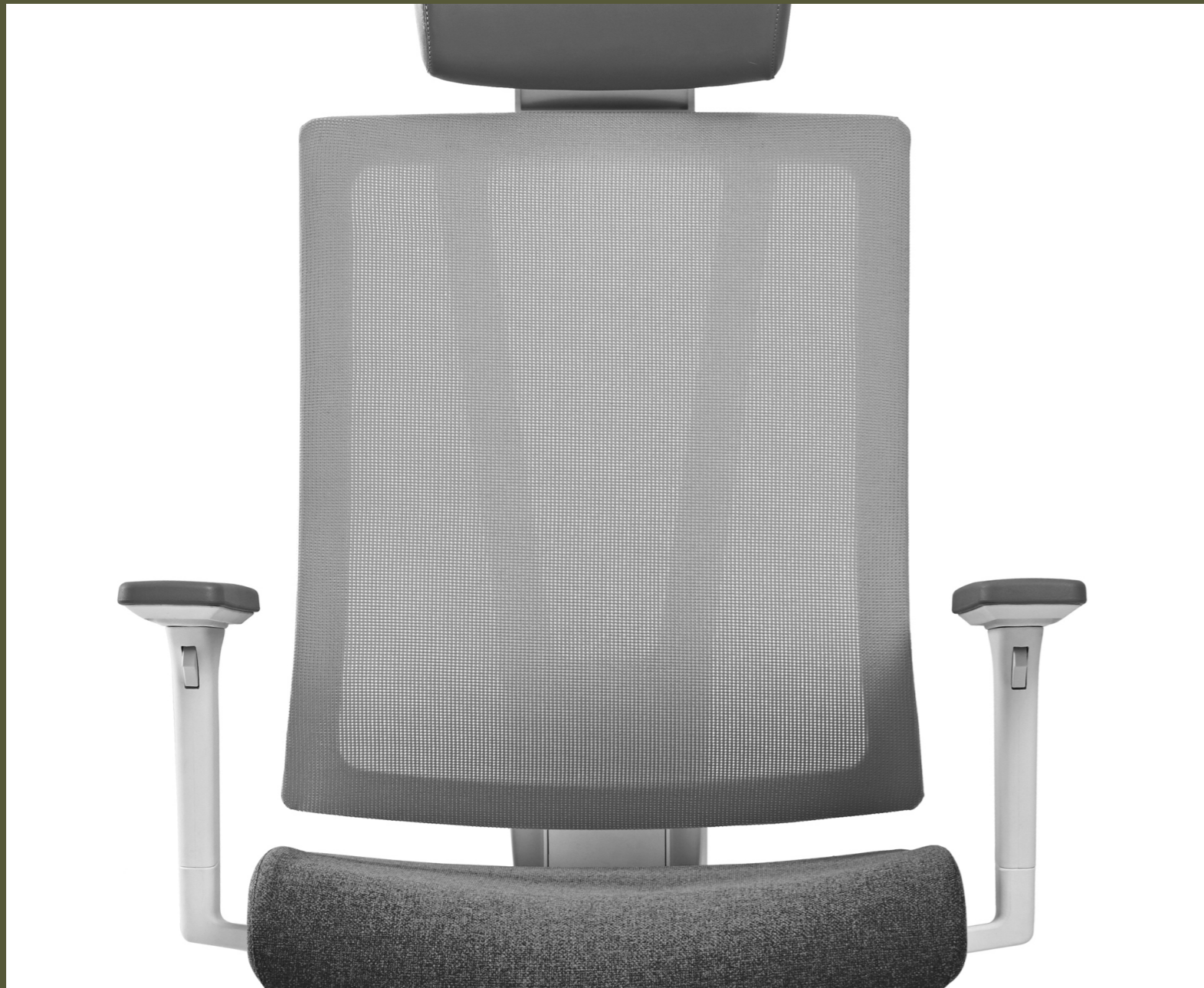

XT43

Semelhante à nossa XT41 e 42, a XT43 consegue acompanhar o legado, revitalizando alguns aspetos como a estética através da simplificação de mecanismos, mas, mantendo a sua ergonomia. O resultado é um produto mais moderno e equilibrado.

Al igual que nuestros XT41 y 42, la XT43 puede mantenerse al día con el legado, revitalizando algunos aspectos, como la estética, simplificando los mecanismos, pero manteniendo su ergonomía. El resultado es un producto más moderno y equilibrado.

Similar to our XT41 and 42, the XT43 can keep up with the legacy, revitalizing some aspects such as aesthetics by simplifying mechanisms but maintaining its ergonomics. The result is a more modern and balanced product.

Tout comme nos XT41 et 42, le XT43 peut suivre le rythme de l'héritage en revitalisant certains aspects tels que l'esthétique en simplifiant les mécanismes tout en maintenant son ergonomie. Le résultat est un produit plus moderne et équilibré.





XT43



XT COLLECTION





XT43

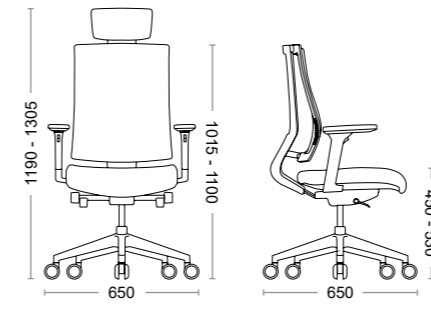

Corpo - Body - Cuerpo - Corps



Preto
Black
Negro
Noir

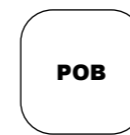

Branco
White
Bianco
Blanc



XT41

A XT41 é uma cadeira versátil e ergonómica que acrescenta um elemento de sofisticação a qualquer local de trabalho. A costa em rede oferece grande conforto e suporte aos seus utilizadores.

XT41 es una silla versátil y ergonómica que añade un elemento de sofisticación a cualquier lugar de trabajo. El respaldo en red ofrece gran comodidad y soporte a sus usuarios.

XT41 is a versatile and ergonomic office chair that adds an element of sophistication to any workspace. The mesh back offers both comfort and support to users.

A XT41 est une chaise versatile et ergonomique qui ajoute un élément de sophistication à chaque espace de travail. Le dossier en filet offre un grand confort et support à ses utilisateurs.





XT41

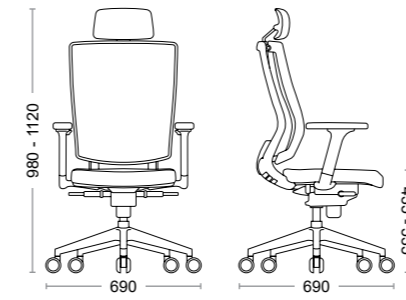

Características - Characteristics - Carácter - Fonctionnalités



Braços reguláveis 2D/ 3D
2D/ 3D adjustable armrests
Apoyabrazos regulables 2D/ 3D
Accoudoirs ajustable 2D/ 3D



Apoio lombar auto ajustável
Self adjustable lumbar support
Soporte lumbar auto ajustable
Appui lombaire auto réglable



Sistema Twist
Twist System
Sistema Twist
System Twist

Corpo - Body - Cuerpo - Corps

POP

Preto
Black
Negro
Noir



XT34

Cada vez mais os produtos devem ter a capacidade de serem personalizados de acordo com as necessidades de cada cliente e espaço. Agora, com a possibilidade do revestimento da costa, a XT34 ganha personalidade através de mais texturas e combinações de cor.

Cada vez más, los productos deben poder personalizarse según las necesidades de cada cliente y espacio. Ahora, con la posibilidad de un revestimiento para el respaldo, el XT34 adquiere personalidad a través de más texturas y combinaciones de colores.

More than ever, products must be able to be customized to the needs of each customer and space. Now, with the possibility of coating the backrest, the XT34 gains personality through more textures and color combinations.

De plus en plus, les produits doivent pouvoir être adaptés aux besoins de chaque client et de chaque espace. Maintenant, avec la possibilité de couvrir le dos, le XT34 gagne en personnalité grâce à plus de textures et de combinaisons de couleurs.







XT34

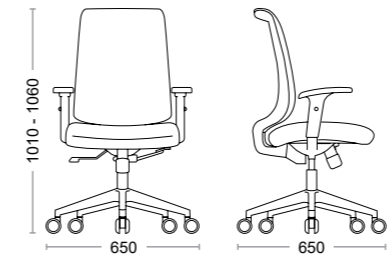

Características - Characteristics - Carácter - Fonctionnalités



Braços fixos e reguláveis
Fixed and adjustable armrests
Apoyabrazos regulables y fijos
Accoudoirs ajustable et fixes



Apoio lombar regulável em altura
Height adjustable lumbar support
Soporte lumbar regulable en altura
Soutien lombaire ajustable en hauteur

Corpo - Body - Cuerpo - Corps

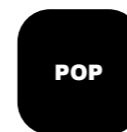

Preto
Black
Negro
Noir



Branco
White
Bianco
Blanc



XT31

Uma XT com dimensões ajustadas à necessidade de rentabilizar o espaço de trabalho sem perda de conforto, A XT31 torna-se uma excelente escolha para dinamizar o espaço de trabalho.

Una XT con dimensiones ajustadas a la necesidad de rentabilizar el espacio de trabajo sin pérdida de confort, La XT31 se convierte en una excelente elección para dinamizar el espacio de trabajo.

A XT with adjusted dimensions to the demand of monetizing the office available space without loss of comfort. The XT31 becomes an excellent choice to dynamize the workspace.

Une XT avec des dimensions adaptées à la nécessité de monétiser l'espace de travail sans perte de confort, le XT31 devient un excellent choix pour dynamiser l'espace de travail.







XT31

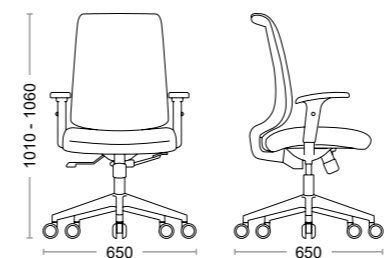

Características - Characteristics - Carácter - Fonctionnalités



Braços fixos e reguláveis
Fixed and adjustable armrests
Apoyabrazos regulables y fijos
Accoudoirs ajustable et fixes



Apoio lombar regulável em altura
Height adjustable lumbar support
Soporte lumbar regulable en altura
Soutien lombaire ajustable en hauteur

Corpo - Body - Cuerpo - Corps

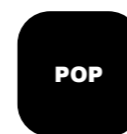

Preto
Black
Negro
Noir



Branco
White
Blanco
Blanc



XT24

Cada vez mais os produtos devem ter a capacidade de serem personalizados de acordo com as necessidades de cada cliente e espaço. Agora, com a possibilidade do revestimento da costa, a XT24 ganha personalidade através de mais texturas e combinações de cor.

Cada vez más, los productos deben poder personalizarse según las necesidades de cada cliente y espacio. Ahora, con la posibilidad de un revestimiento para el respaldo, el XT24 adquiere personalidad a través de más texturas y combinaciones de colores.

More than ever, products must be able to be customized to the needs of each customer and space. Now, with the possibility of coating the backrest, the XT24 gains personality through more textures and color combinations.

De plus en plus, les produits doivent pouvoir être adaptés aux besoins de chaque client et de chaque espace. Maintenant, avec la possibilité de couvrir le dos, le XT24 gagne en personnalité grâce à plus de textures et de combinaisons de couleurs.



XT24

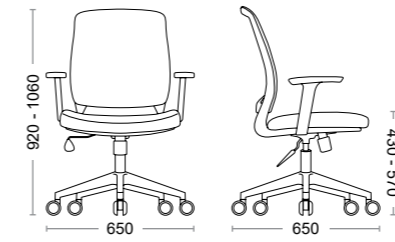

Características - Characteristics - Carácter - Fonctionnalités



Braços fixos e reguláveis
Fixed and adjustable armrests
Apoyabrazos regulables y fijos
Accoudoirs ajustable et fixes



Apoio lombar
Lumbar support
Soporte lumbar
Soutien lombaire

Corpo - Body - Cuerpo - Corps

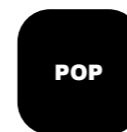

Preto
Black
Negro
Noir



Cinza
Grey
Gris
Gris



XT23

É um modelo que combina o conforto, design e funcionalidade. As suas linhas curvas fazem da XT23 uma cadeira operativa moderna e versátil, que se adapta a qualquer espaço.

Es un modelo que combina el confort, diseño y funcionalidad. Sus líneas curvas hacen de la XT23 una silla operativa moderna y versátil, que se adapta a cualquier espacio.

This model combines comfort, design and functionality. Its curved lines make XT23 a versatile and modern operative chair that easily adapts to any space.

Est un modèle qui combine le confort, design et la fonctionnalité. Ses lignes courbes font de la XT23 une chaise opérative moderne et versatile, qui s'adapte à quelconque espace.







XT23

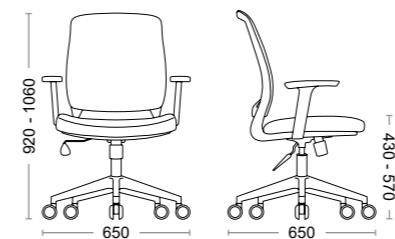

Características - Characteristics - Carácter - Fonctionnalités



Braços fixos e reguláveis
Fixed and adjustable armrests
Apoyabrazos regulables y fijos
Accoudoirs ajustable et fixes



Apoio lombar
Lumbar support
Soporte lumbar
Soutien lombaire

Corpo - Body - Cuerpo - Corps

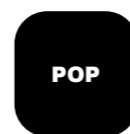

Preto
Black
Negro
Noir



Cinza
Grey
Gris
Gris



YORK

A linha "York" é simplesmente um sinónimo de diversidade. Composta por três modelos distintos, que variam na altura do casco, a "York" torna-se num produto adaptável a qualquer espaço ou ambiente de trabalho.

La línea "York" es simplemente un sinónimo de diversidad. Compuesta por tres modelos distintos, que varían a la altura del casco, la York se convierte en un producto adaptable a cualquier espacio o ambiente de trabajo.

The "York" line is simply a synonym for diversity. Composed of three different models, which vary in back height, the "York" becomes a product adaptable to any space or work environment.

La ligne "York" est simplement synonyme de diversité. Composé de trois modèles différents, dont varie la hauteur de la coque, "York" devient un produit adaptable à n'importe quel espace ou l'environnement de travail.

























York XL

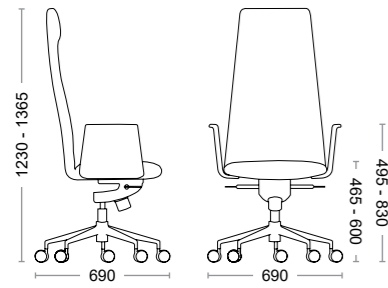

York M

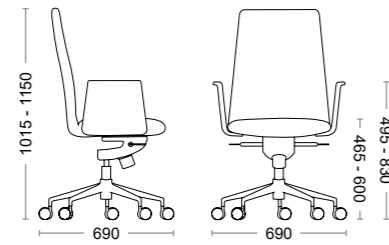

York XS.1

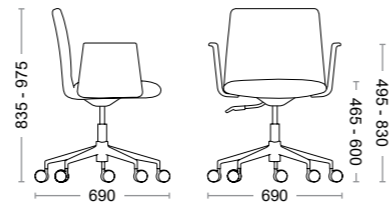

York XS.2

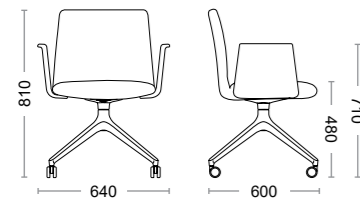

York XS.3

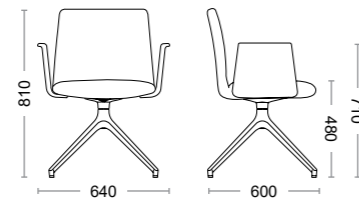

York XS.4

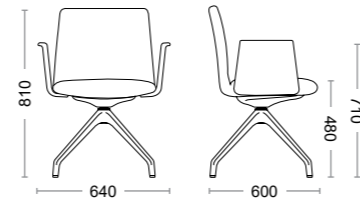

York XS.5

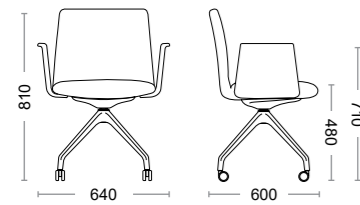

York XS.6

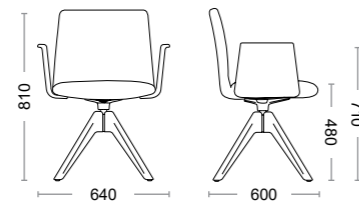

York XS.7

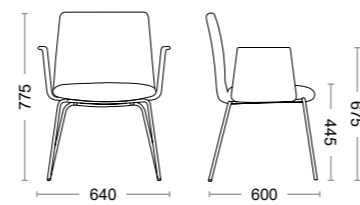

York XS.8

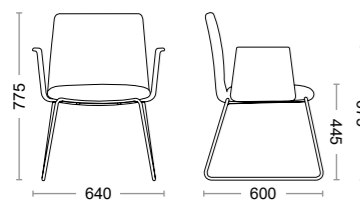

York - Bench

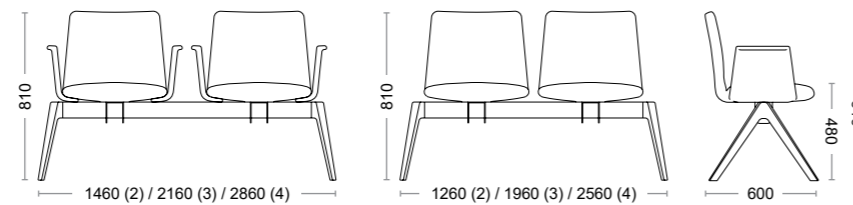

York Lounge XL

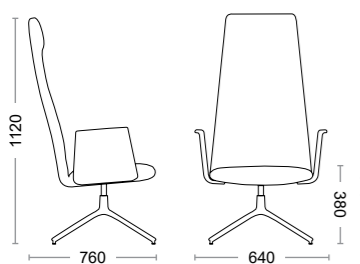

York Lounge M

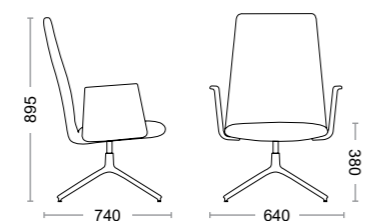

York Home - Large

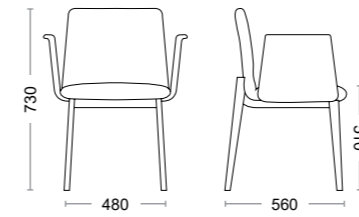

York Home - Slim

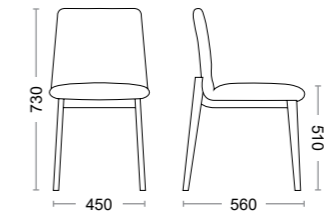

York Home - Lounge

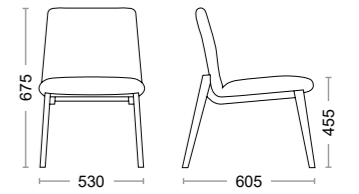

York Home - Stool

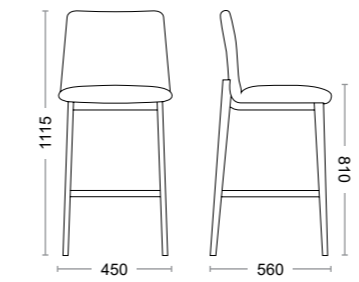

Estrutura - Frame - Estructura - Structure





YORK WOOD

A linha "York" é simplesmente um sinónimo de diversidade. Composta por três modelos distintos, que variam na altura do casco, a "York" torna-se num produto adaptável a qualquer espaço ou ambiente de trabalho.

La línea "York" es simplemente un sinónimo de diversidad. Compuesta por tres modelos distintos, que varían a la altura del casco, la York se convierte en un producto adaptable a cualquier espacio o ambiente de trabajo.

The "York" line is simply a synonym for diversity. Composed of three different models, which vary in back height, the "York" becomes a product adaptable to any space or work environment.

La ligne "York" est simplement synonyme de diversité. Composé de trois modèles différents, dont varie la hauteur de la coque, "York" devient un produit adaptable à n'importe quel espace ou l'environnement de travail.











York Wood XL



York Wood M

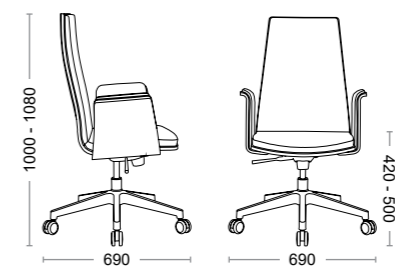

York Wood XS.1

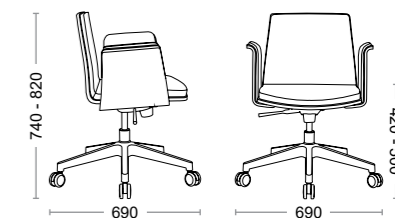

York Wood Lounge XL.1

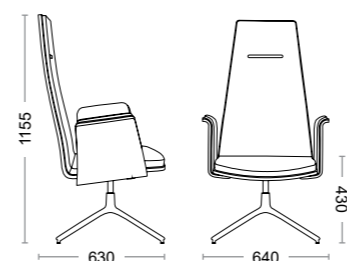

York Wood Lounge M.1

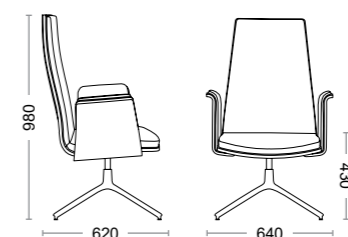

York Wood Lounge XL.2

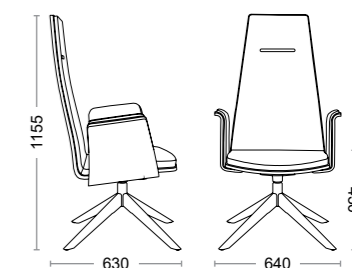

York Wood Lounge M.2

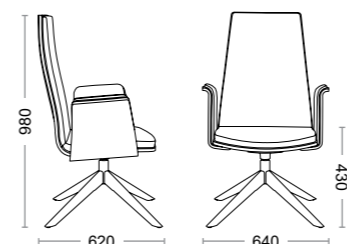

York Wood XS.2

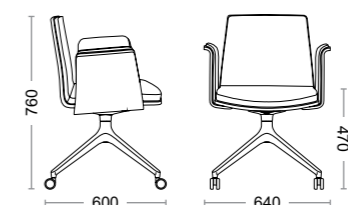

York Wood XS.3

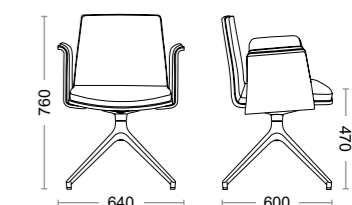

York Wood XS.4

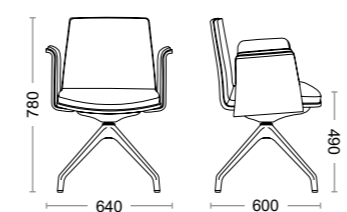

York Wood XS.5

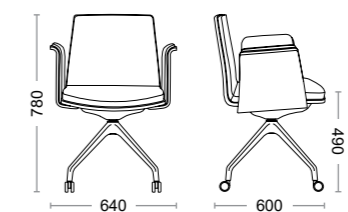

York Wood XS.6

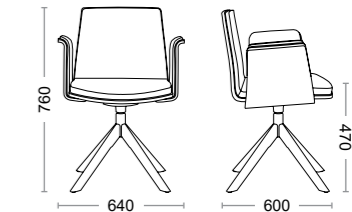

Estrutura - Frame - Estructura - Structure



RAL 9005

Preto
Black
Negro
Noir



RAL 9016

Branco
White
Blanco
Blanc



Cromado
Chrome
Cromado
Chromé



Faia
Beech
Haya
Hêtre



ARK

Com linhas curvas bastantes suaves e proporcionalmente alinhadas, a cadeira Ark reúne uma série de características interessantes. Não só de um ponto de vista ergonómico e funcional, onde todo o corpo fica perfeitamente ajustado à cadeira. Mas, também, de um ponto de vista estético.

Con líneas curvas bastantes suaves y proporcionalmente alineadas, la silla Ark reúne una serie de características interesantes. No sólo desde un punto de vista ergonómico y funcional, donde todo el cuerpo se ajusta perfectamente a la silla. Pero, también, desde un punto de vista estético.

With fairly smooth and proportionally aligned curved lines, the Ark Chair brings together a number of interesting features. Not only from an ergonomic and functional point of view, where the whole body is perfectly adjusted to the chair. But also, from an aesthetic point of view.

Avec des lignes courbes assez douces et proportionnellement alignées, la chaise Ark réunit un certain nombre de caractéristiques intéressantes. Pas seulement d'un point de vue ergonomique et fonctionnel, où tout le corps est parfaitement ajusté à la chaise. Mais aussi, d'un point de vue esthétique.





Ark

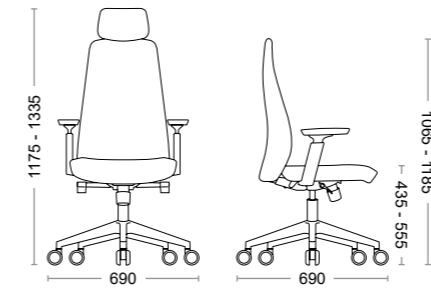

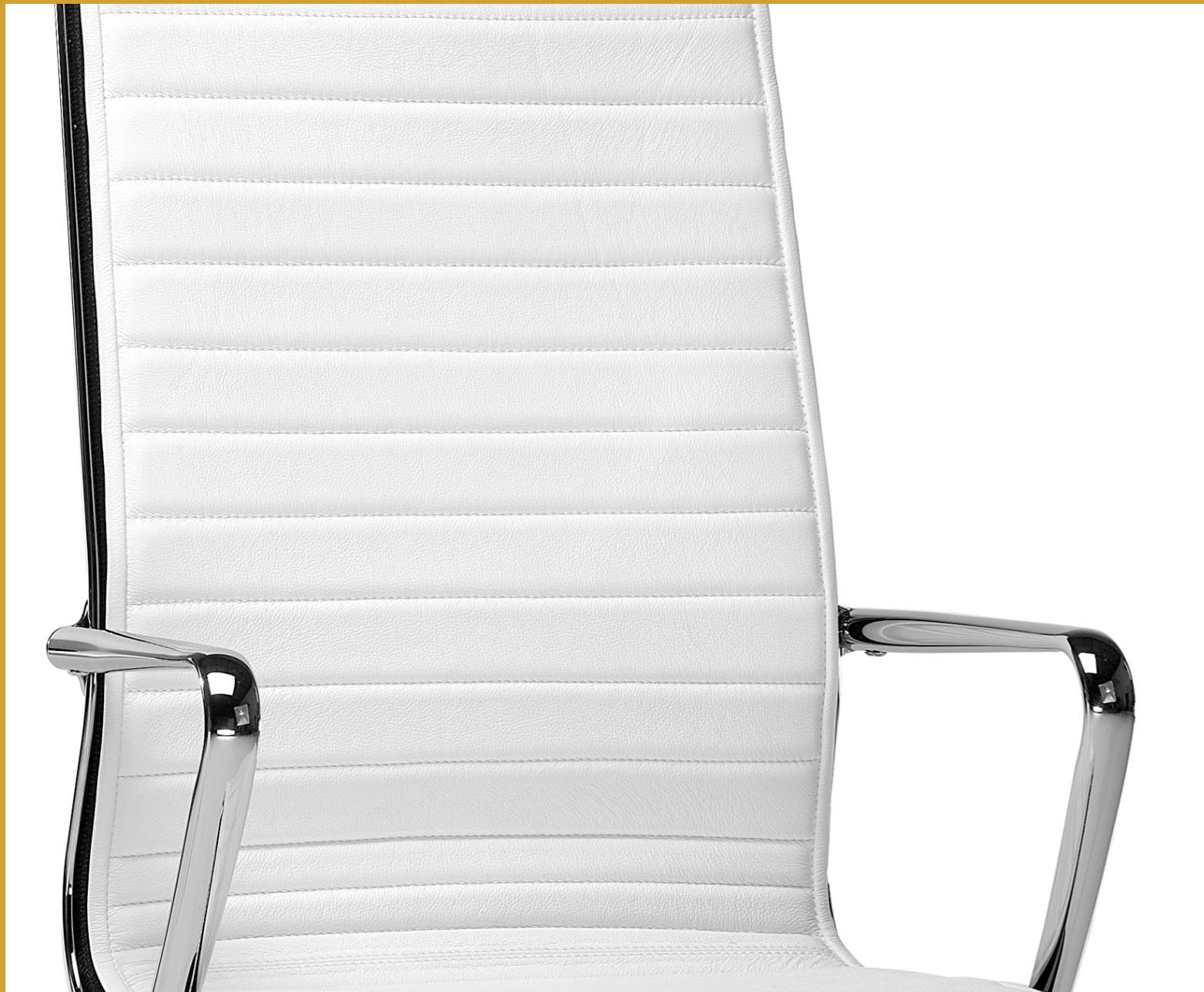

HIDRA

Dadas as suas características multifacetadas, a Hidra revela-se dinâmica e flexível, adaptando-se à crescente necessidade de bem-estar de qualquer escritório.

Debido a sus características polifacéticas, la silla Hidra se revela dinámica y flexible, adaptándose a la creciente necesidad de bienestar en cualquier oficina.

Given its multi-faceted characteristics, Hidra proves to be dynamic and flexible, adapting to the growing need for welfare in any office.

Etant donné ses fonctions multiples, Hidra se révèle dynamique et flexible, s'adaptant à un besoin croissant de bien être de quelconque bureau.



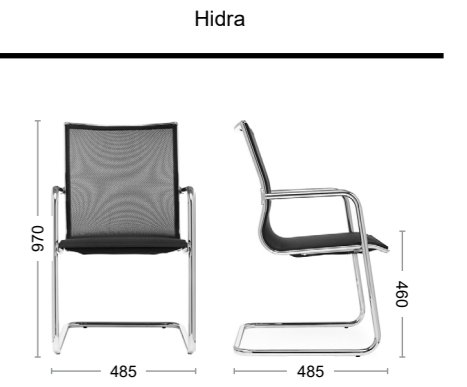
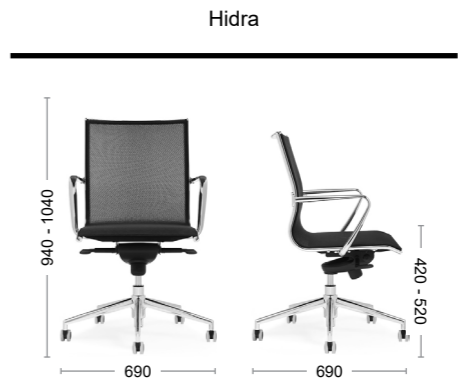
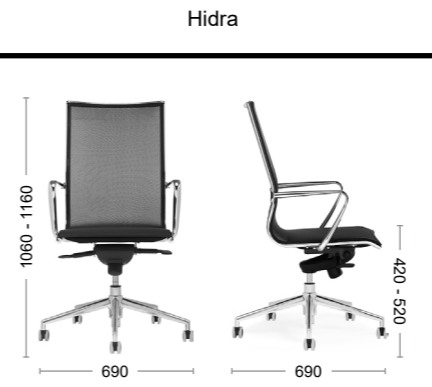



VIVA

Com linhas sóbrias e elegantes, a Viva, concilia o conforto com a excelência de um design inovador. As linhas características da Viva trazem harmonia a qualquer ambiente. Foi criada especificamente para agradar tanto ao consumidor mais clássico como ao mais vanguardista.

Con líneas sobrias y elegantes, Viva concilia el confort con la excelencia de un diseño innovador. Las líneas características de Viva traen armonía a cualquier ambiente. Ha sido creada especialmente para gustar tanto al consumidor más clásico como al más vanguardista.

With its sober and elegant lines, Viva combines comfort with the excellence of an innovative design. The characteristic lines of Viva bring harmony to any environment. It has been designed to please both classical and avant-garde consumers.

Avec des lignes sobres et élégantes, Viva, concilie le confort avec l'excellence d'un design innovateur. Les lignes caractéristiques de Viva donnent de l'harmonie à quelconque ambiance. Celle-ci a été créée spécifiquement pour plaire à la fois au consommateur plus classique comme au plus avant-garde.





Dados Técnicos | Technical Data | Datos Tecnicos | Données Techniques

Viva

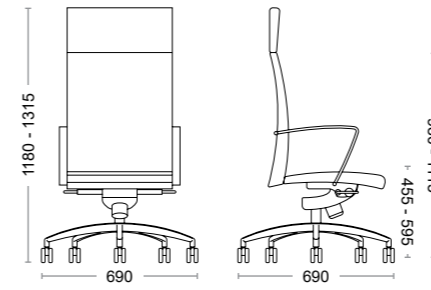

Viva

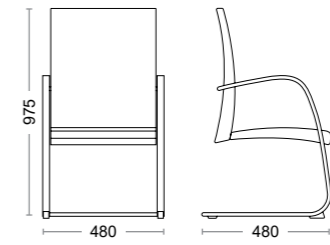

VIVA



D60

Conformada na íntegra, através do uso de rede, o que lhe garante uma forma extremamente orgânica e leve, a cadeira D60 revela o lado sofisticado do design.

Completamente conformada mediante el uso de red, lo que le garantiza una forma extremadamente orgánica y liviana, la silla D60 revela el lado sofisticado del diseño.

Completely shaped through the use of netting, which guarantees it an extremely organic and lightweight shape, the D60 chair reveals the sophisticated side of the design.

Complètement façonnée grâce à l'utilisation d'un filet, ce qui lui garantit une forme extrêmement organique et légère, la chaise D60 révèle le côté sophistiqué du design.



D60

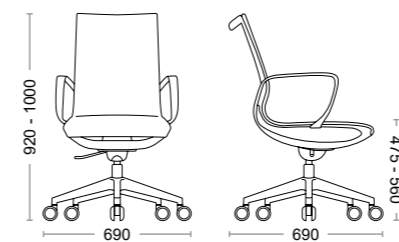

Corpo - Body - Cuerpo - Corps

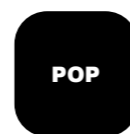

POP

Preto
Black
Negro
Noir



POB

Branco
White
Blanco
Blanc



D40

Conformada na íntegra, através do uso de rede, o que lhe garante uma forma extremamente orgânica e leve, a cadeira D40 revela o lado sofisticado do design.

Completamente conformada mediante el uso de red, lo que le garantiza una forma extremadamente orgánica y liviana, la silla D40 revela el lado sofisticado del diseño.

Completely shaped through the use of netting, which guarantees it an extremely organic and lightweight shape, the D40 chair reveals the sophisticated side of the design.

Complètement façonnée grâce à l'utilisation d'un filet, ce qui lui garantit une forme extrêmement organique et légère, la chaise D40 révèle le côté sophistiqué du design.





D40

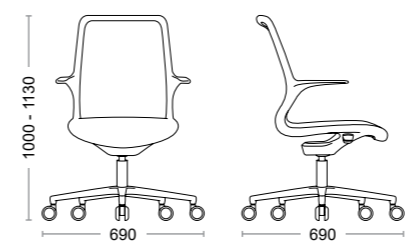

Corpo - Body - Cuerpo - Corps

POP

Preto
Black
Negro
Noir



D70

Com uma aparência moderna e leve o modelo D70 consegue cruzar o conforto com a elegância através da aliança entre design e engenharia.

De apariencia moderna y liviana, el modelo D70 logra cruzar la comodidad con la elegancia a través de la alianza entre diseño e ingeniería.

With a modern and light appearance, the D70 model manages to cross comfort with elegance through the alliance between design and engineering.

D'apparence moderne et légère, le modèle D70 parvient à croiser confort et élégance grâce à l'alliance du design et de l'ingénierie.



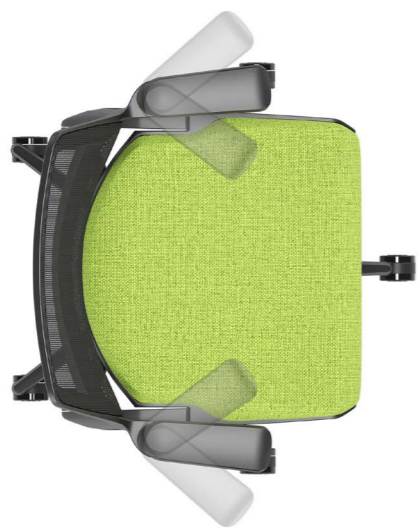

D70

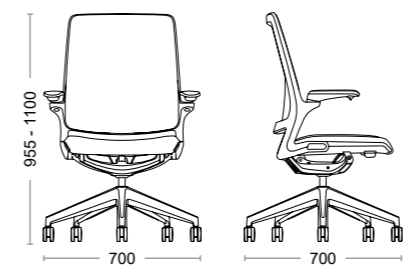

Corpo - Body - Cuerpo - Corps

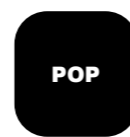

Preto
Black
Negro
Noir

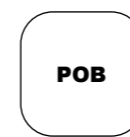

Branco
White
Blanco
Blanc

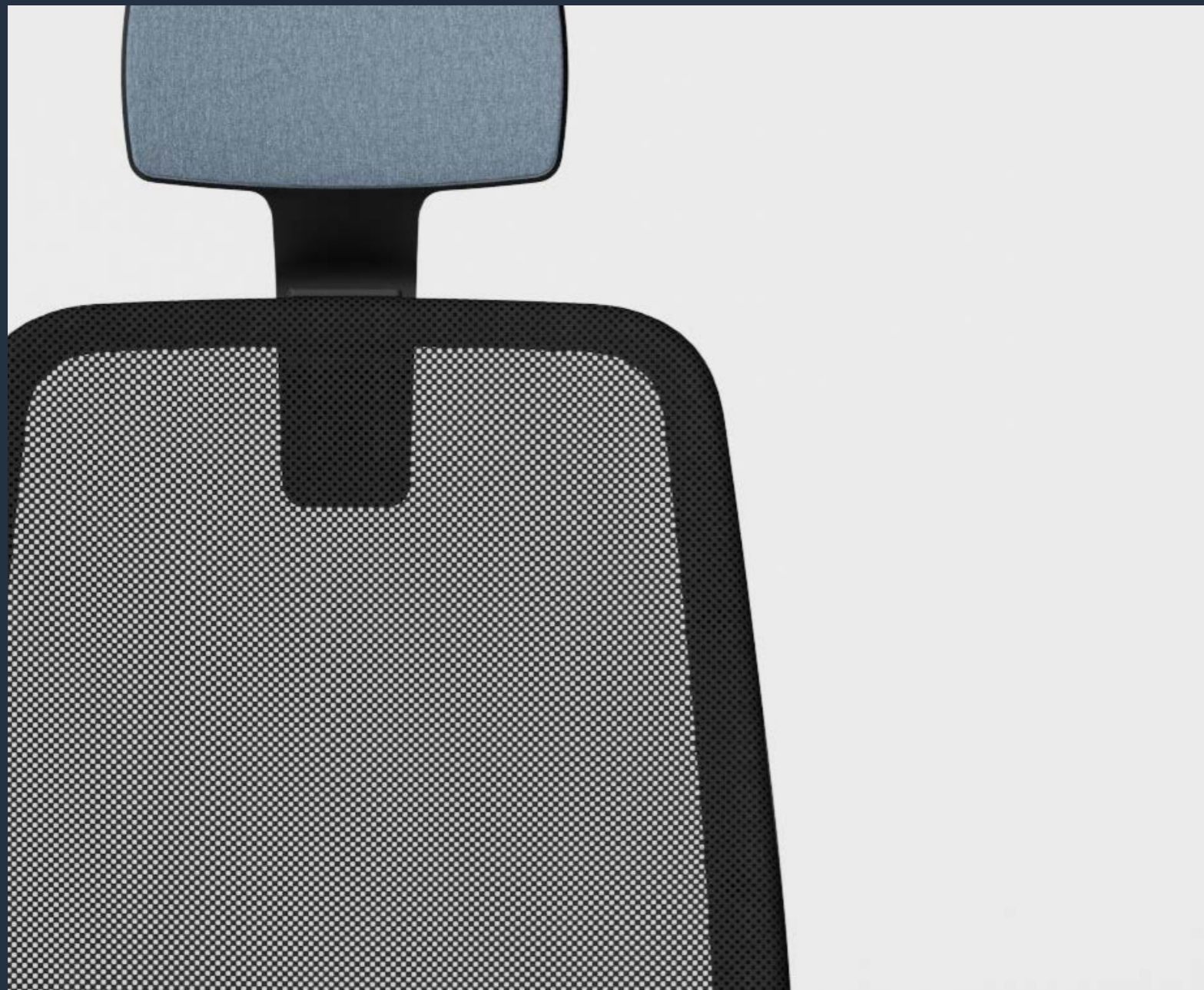

TRON

Os aspetos a realçar da composição deste modelo são o apoio de cabeça ajustável em altura e o apoio lombar, que permitem ao usuário adaptar as suas zonas corporais lombar e cabeça a qualquer conformação anatômica.

Destacan en la composición de este modelo el reposacabezas regulable en altura y el soporte lumbar, que permiten al usuario adaptar su zona corporal, lumbar y de la cabeza a cualquier forma anatómica.

Highlights of the composition of this model are the height-adjustable headrest and the lumbar support, which allow the user to adapt their body, lumbar and head areas to any anatomical shape.

Les points forts de la composition de ce modèle sont l'appui-tête réglable en hauteur et le support lombaire, qui permettent à l'utilisateur d'adapter les zones du corps, des lombaires et de la tête à n'importe quelle forme anatomique.



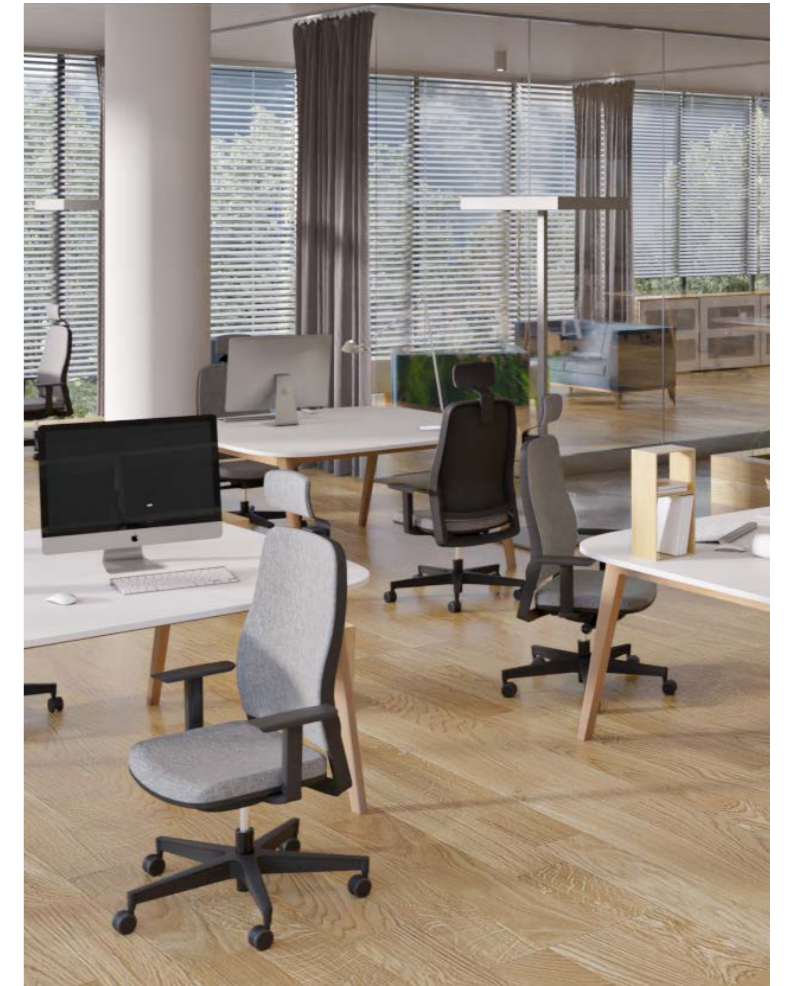

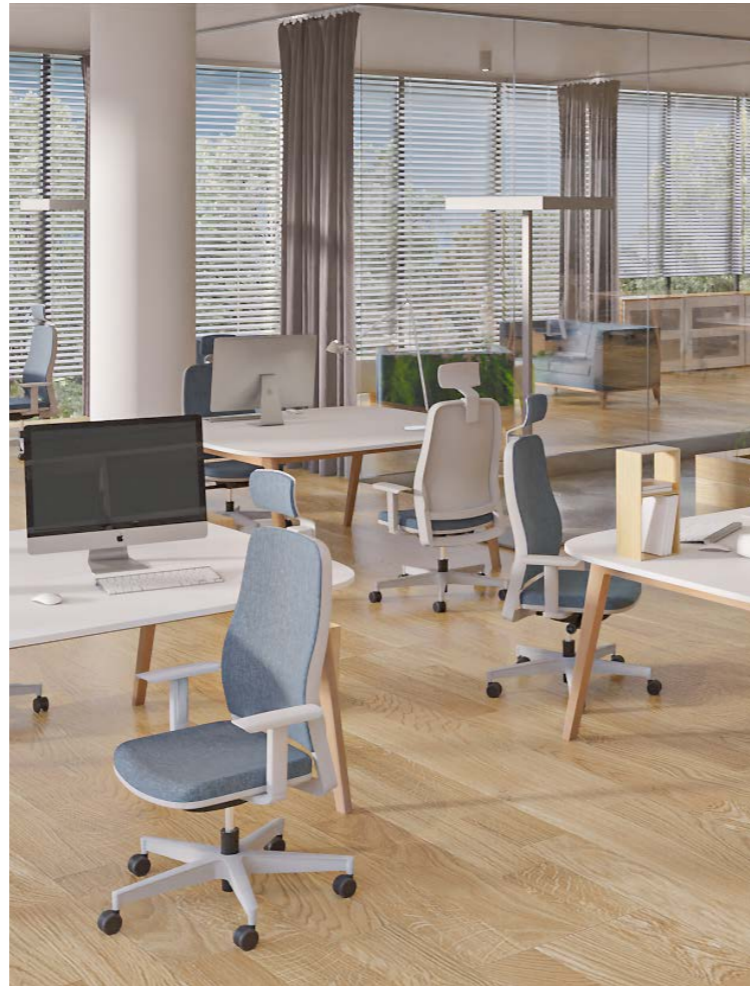

Tron

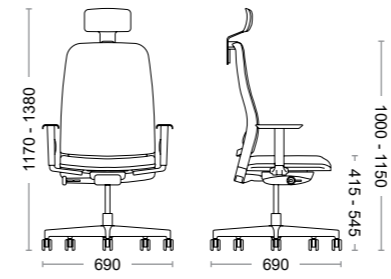

Corpo - Body - Cuerpo - Corps



Preto
Black
Negro
Noir

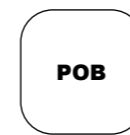

Branco
White
Blanco
Blanc



T-ONE

Caracterizada pela simplicidade, mas sofisticada. A T-One pode integrar vários cenários devido ao seu leque de opções. Possibilidade de corpo branco ou preto.

Caracterizado por la sencillez, pero sofisticado. T-One puede integrar varios escenarios debido a su abanico de opciones. Posibilidad de carrocería blanca o negra.

Characterized by simplicity, yet sophisticated. T-One can integrate various scenarios due to its range of options. Possibility of white or black body.

Caractérisé par la simplicité, mais sophistiqué. T-One peut intégrer différents scénarios grâce à sa gamme d'options. Possibilité de corps blanc ou noir.









Dados Técnicos | Technical Data | Datos Tecnicos | Données Techniques

T-One.1

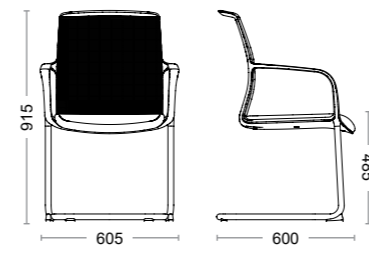

T-One.2

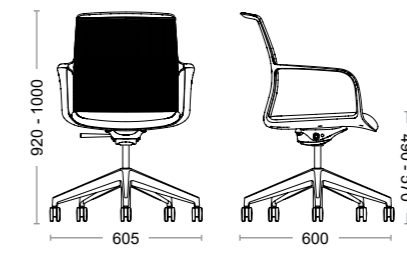

T-One.3

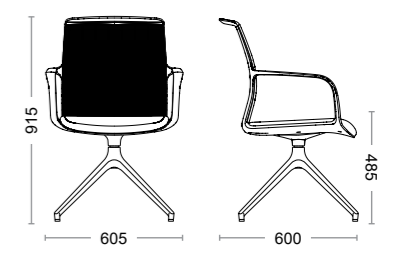

T-One.4

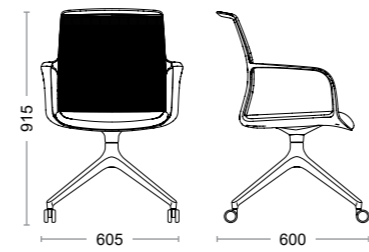

Estrutura - Frame - Estructura - Structure



Preto
Black
Negro
Noir

Branco
White
Blanco
Blanc

Cromado
Chrome
Cromado
Chromé

Corpo - Body - Cuerpo - Corps



Preto
Black
Negro
Noir

Branco
White
Blanco
Blanc



BOUNCE

Os tempos mudam, e os espaços de trabalho também. Cada vez mais ágeis, os escritórios têm-se revestido de soluções como o Bounce: práticas, dinâmicas, ajustáveis a vários cenários e extremamente ergonómicas.

Los tiempos cambian y los espacios de trabajo también. Las oficinas, cada vez más ágiles, se han alineado con soluciones como Bounce: prácticas, dinámicas, ajustables a diversos escenarios y extremadamente ergonómicas.

Times change, and workspaces, too. More and more agile, offices have been lined with solutions like Bounce: practical, dynamic, adjustable to various scenarios and extremely ergonomic.

Les temps changent et les espaces de travail aussi. De plus en plus agiles, les bureaux regorgent de solutions telles que Bounce: pratiques, dynamiques, adaptables à différents scénarios et extrêmement ergonomiques.





Bounce

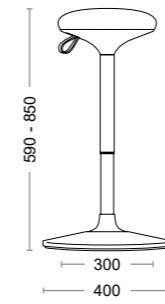



WAVE

Versátil, leve, moderno e com 3 cores diferentes disponíveis, o banco Wave é um produto capaz de transformar qualquer área de trabalho colaborativo em pequenos momentos de lazer. A altura ajustável pode ser usada como um banco alto ou baixo.

Versátil, ligero, moderno y con 3 colores diferentes disponibles, el banco Wave es un producto capaz de transformar cualquier área de trabajo colaborativo en pequeños momentos de ocio. La altura regulable se puede utilizar como banco alto o bajo.

Versatile, light, modern and with 3 different colors available, the Wave bench is a product capable of transforming any collaborative work area into small moments of leisure. Adjustable height can be used as a high or low bench.

Polyvalent, léger, moderne et avec 3 couleurs différentes disponibles, le banc Wave est un produit capable de transformer n'importe quel espace de travail collaboratif en petits moments de loisirs. La hauteur réglable peut être utilisée comme banc haut ou bas.



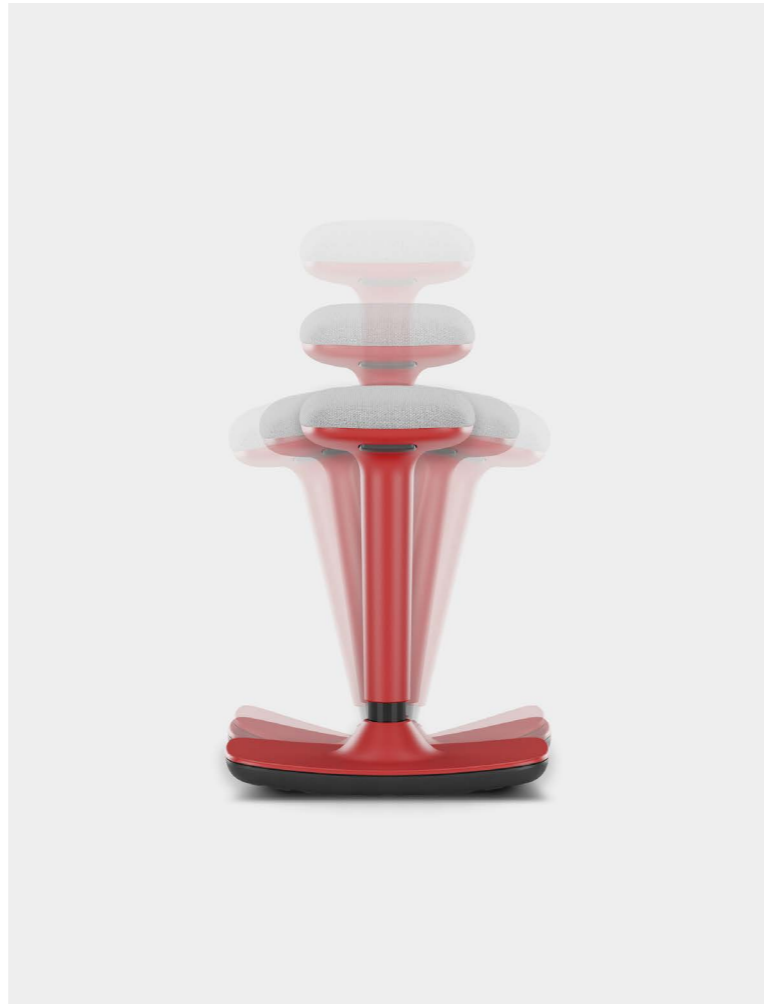

Wave

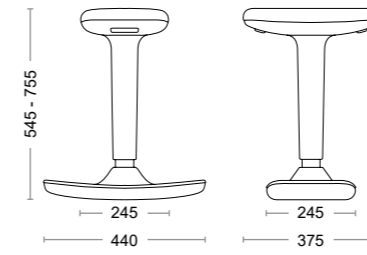



ROCK

A Rock é o nosso primeiro projeto focado no desenvolvimento de um casco através do processo de injeção plástica e representa a nossa vontade de criar produtos diferenciados e à nossa maneira. Trata-se de uma cadeira multi-uso na medida em que funciona na perfeição em qualquer espaço.

Rock es nuestro primer proyecto centrado en el desarrollo de carcasas de inyección de plástico y representa nuestro deseo de crear productos diferenciados a nuestra manera. Es una silla polivalente ya que funciona a la perfección en cualquier espacio.

Rock is our first project focused on the development of a plastic injection shells and it represents our desire to create differentiated products in our own way. It is a multi-purpose chair as it works perfectly in any space.

Rock est notre premier projet axé sur le développement d'une coque en injection plastique et il représente notre volonté de créer des produits différenciés à notre façon. C'est une chaise polyvalente car elle fonctionne parfaitement dans n'importe quel espace.

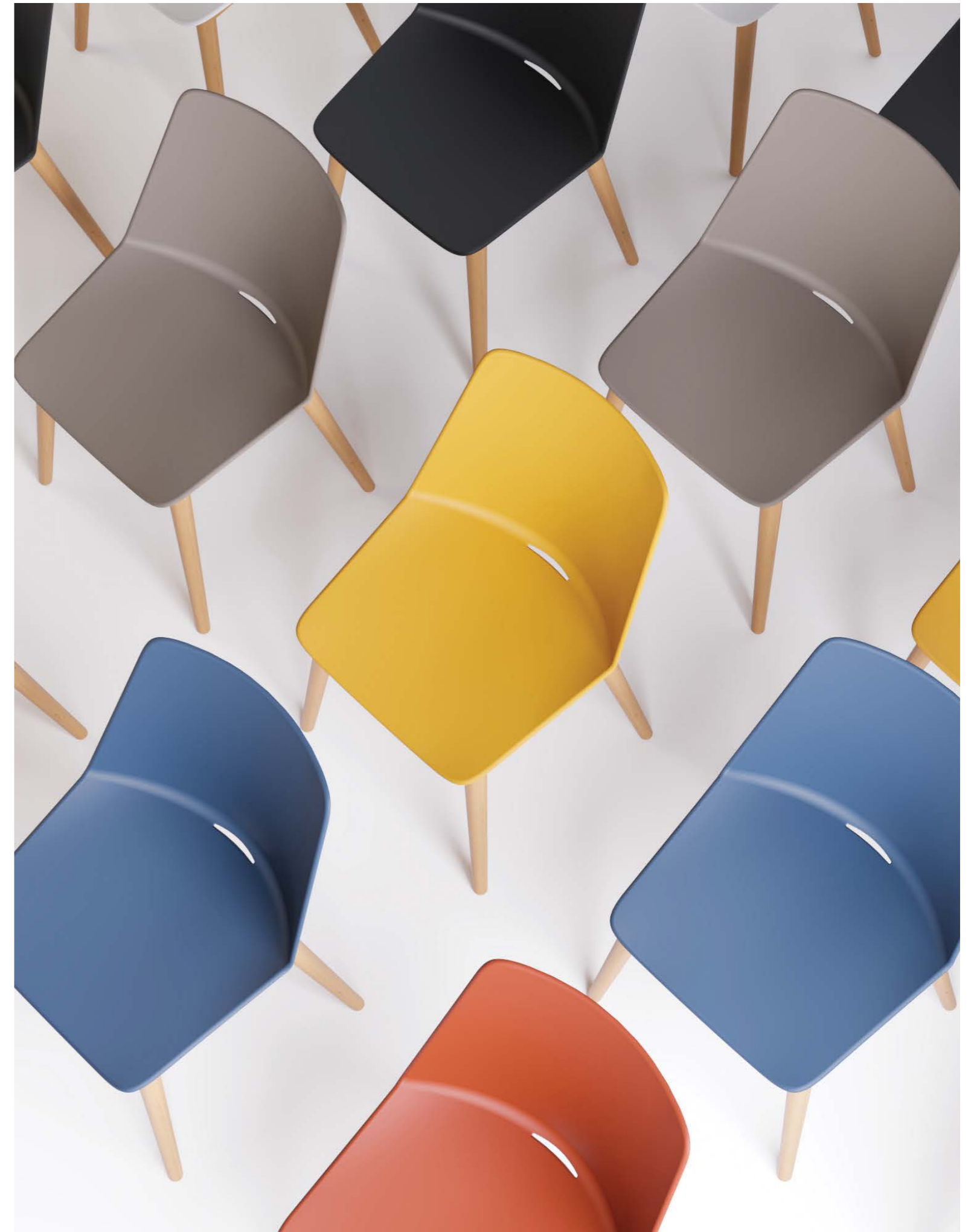























Rock.1

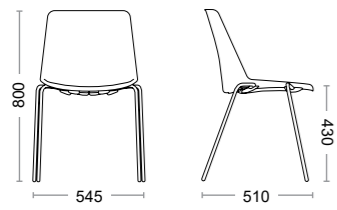

Rock.2

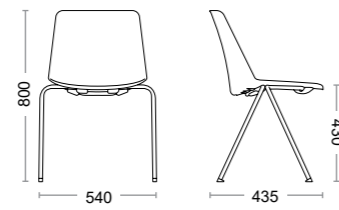

Rock.3

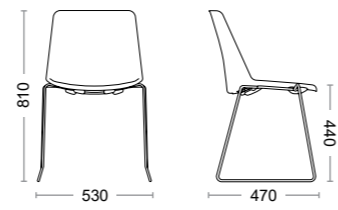

Rock.4

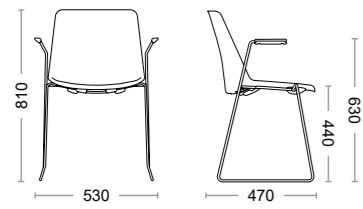

Rock.5

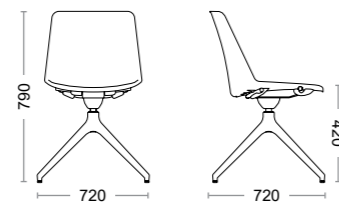

Rock.6

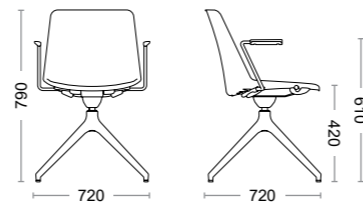

Rock.7

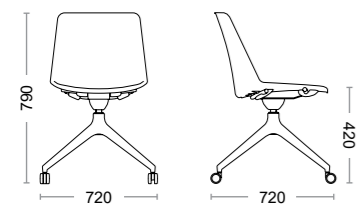

Rock.8

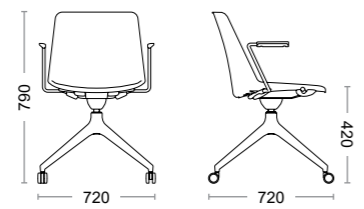

Rock.9

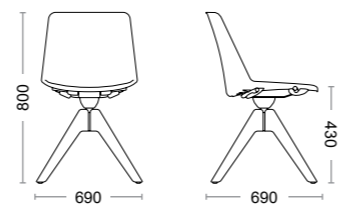

Rock.10

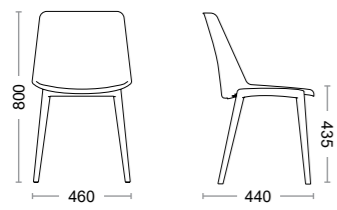

Rock.11

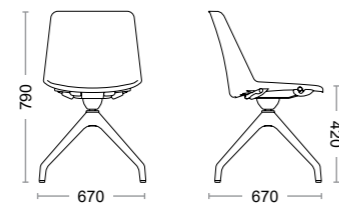

Rock.12

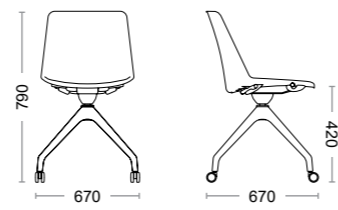

Rock.13

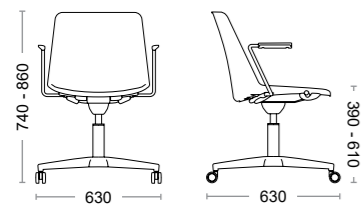

Rock.14

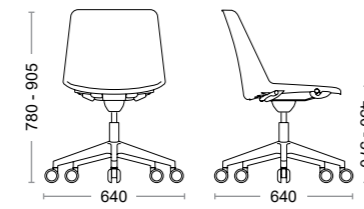

Rock.15

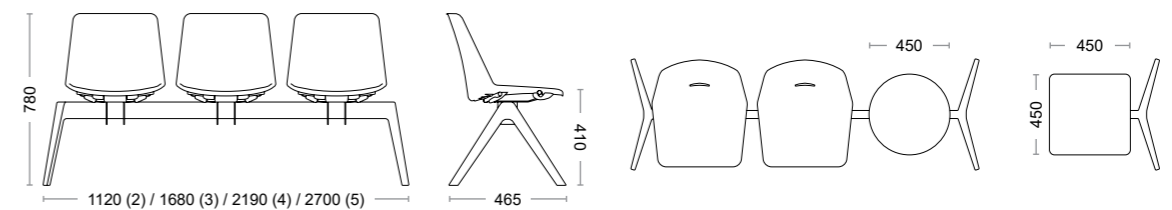

Rock.16

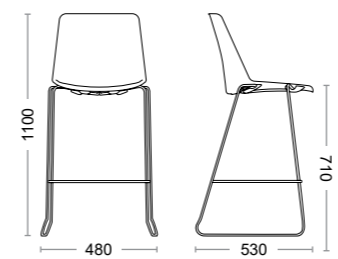

Rock.17

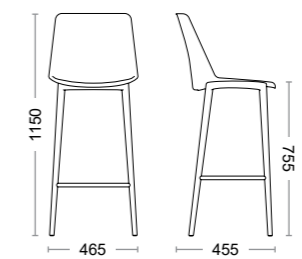

Opções de Casco - Shell Options - Opciones de casco - Options de coque



Estofado
Upholstered
Tapizado
Tapissée



Assento estofado
Upholstered seat
Asiento tapizado
Siège tapissée



Polipropileno
Polypropylene
Polipropileno
Polypropylène

Corpo - Body - Cuerpo - Corps



Brick Red



Petrol Blue



Mustard



Taupe



Dark Grey



White

Estrutura - Frame - Estructura - Structure

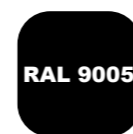

RAL 9005

Preto
Black
Negro
Noir



RAL 9016

Branco
White
Blanco
Blanc



Polido
Polished
Pulido
Brilliant



Faia
Beech
Haya
Hêtre

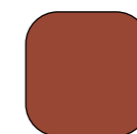

Brick Red



Petrol Blue

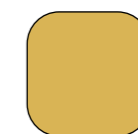

Mustard

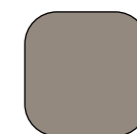

Taupe



TOMMY

Enquanto cadeira multiuso, a Tommy reveste-se de uma série de tipologias essenciais para as dinâmicas de um espaço de trabalho do século 21. Particularmente interessante pela sua aparência harmoniosa, é essencial para equipar qualquer escritório na totalidade, mantendo uma linguagem uniforme.

Como silla multiuso, Tommy tiene una serie de tipologías que son esenciales para la dinámica de un espacio de trabajo del siglo 21. Particularmente interesante por su armoniosa apariencia, es esencial para equipar cualquier oficina en su totalidad mientras se mantiene un lenguaje uniforme.

As a multipurpose chair, Tommy has a number of typologies that are essential to the dynamics of a 21st century workspace. Particularly interesting for its harmonious look, it is essential to furnish any office in its entirety while maintaining a uniform language.

Fauteuil polyvalent, Tommy propose une gamme de typologies essentielles à la dynamique d'un espace de travail du XXIe siècle, notamment pour son look harmonieux. Il est essentiel d'équiper tous les bureaux dans leur intégralité, tout en maintenant un langage uniforme.











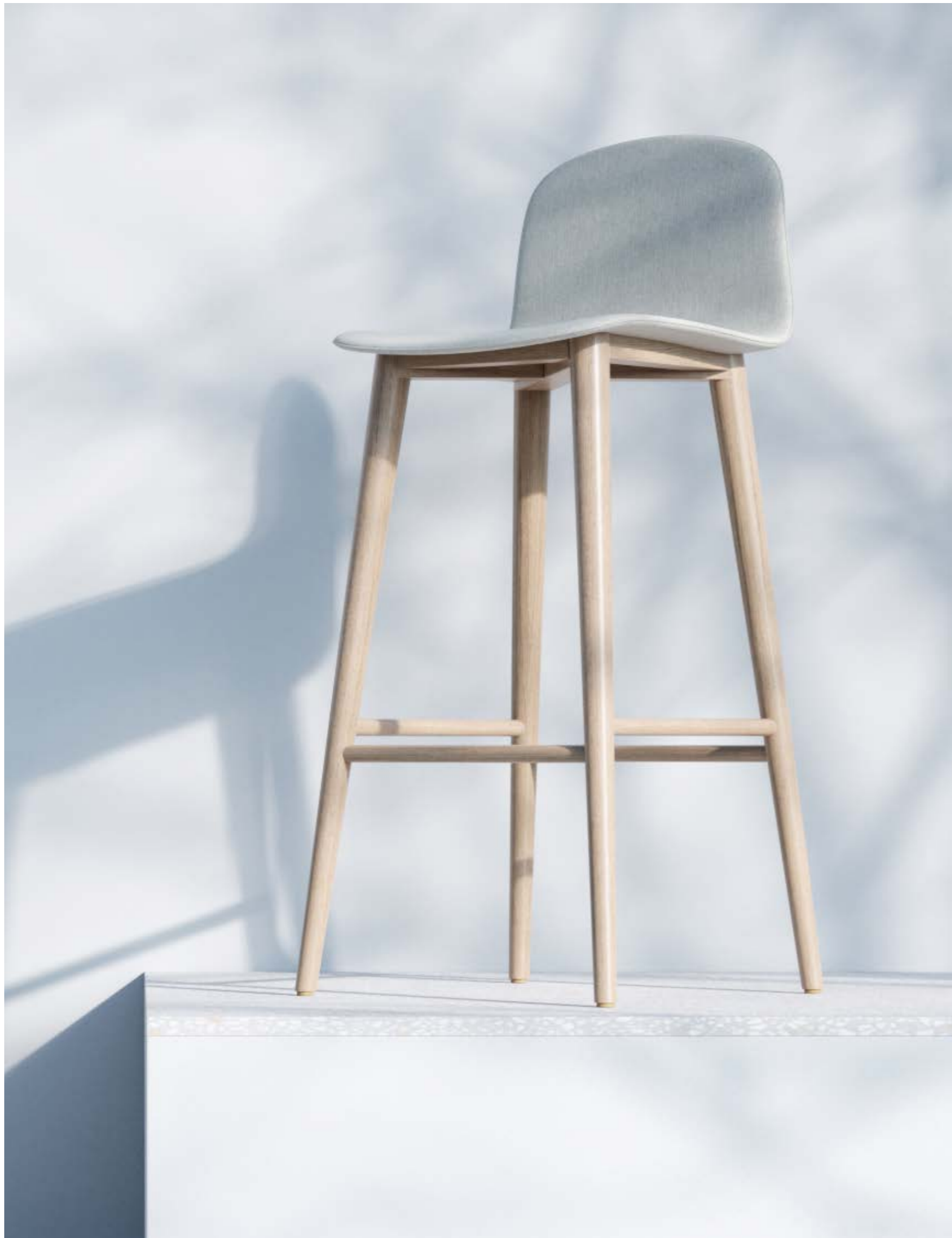

Tommy.1

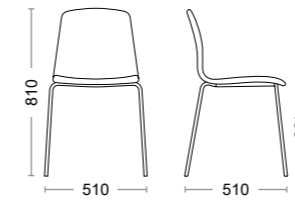

Tommy.2

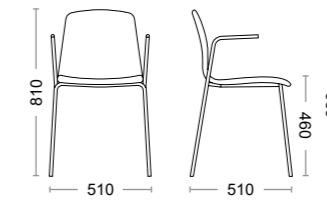

Tommy.3

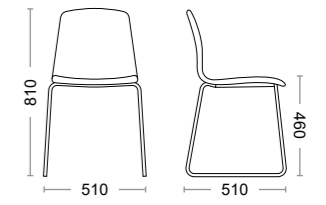

Tommy.4

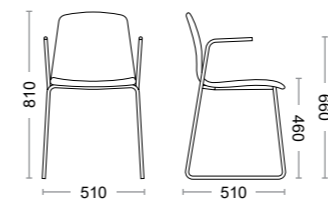

Tommy.5

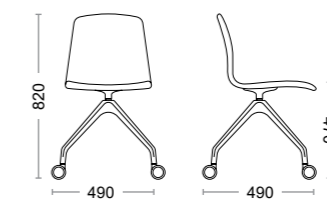

Tommy.6

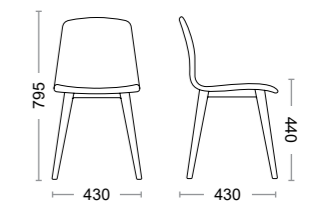

Tommy.7



Tommy.8

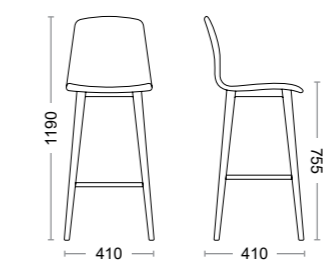

Tommy.9

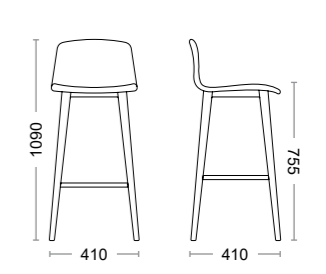

Tommy.10

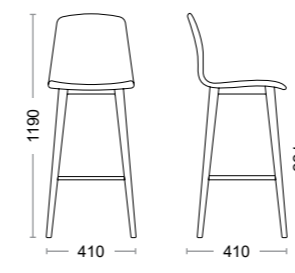

Tommy.11

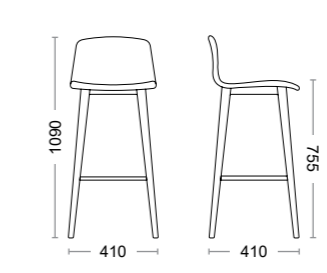

Tommy.12

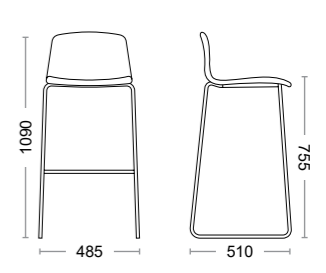

Tommy.13

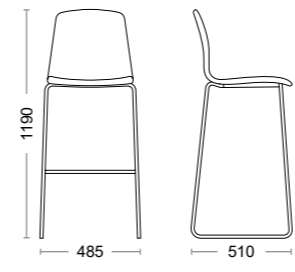

Estrutura - Frame - Estructura - Structure

RAL 9005

Preto
Black
Negro
Noir

RAL 9006

Cinza
Grey
Gris
Gris

RAL 9016

Branco
White
Blanco
Blanc

Cromado
Chrome
Cromado
Chromé

Faia
Beech
Haya
Hêtre



MIZA

A cadeira Miza destaca-se pela personalização. Com imensas variações relativamente às bases e cascos permitindo criar soluções e tipologias para diferentes cenários.

La silla Miza destaca por su personalización. Con inmensas variaciones en cuanto a bases y cascos, creando soluciones y tipologías para diferentes escenarios.

The Miza chair stands out for its customization. With immense variations in terms of bases and hulls, creating solutions and typologies for different scenarios.

La chaise Miza se distingue par sa personnalisation. Avec d'immenses variations en termes de bases et de coques, créant des solutions et des typologies pour différents scénarios.













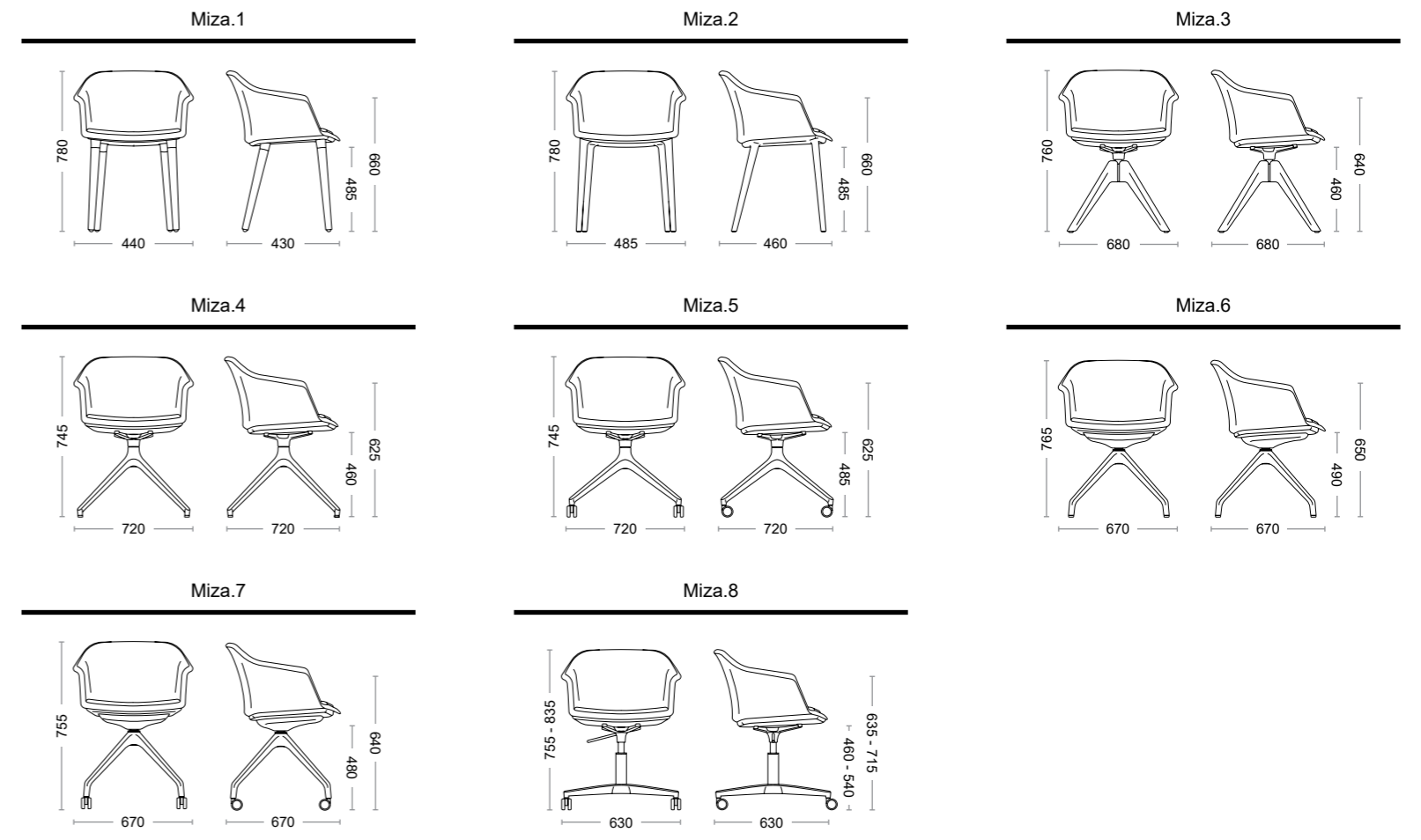

Opções de Casco - Shell Options - Opciones de casco - Options de coque



Corpo - Body - Cuerpo - Corps



Estrutura - Frame - Estructura - Structure

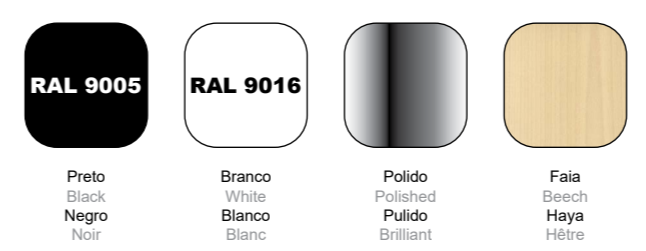

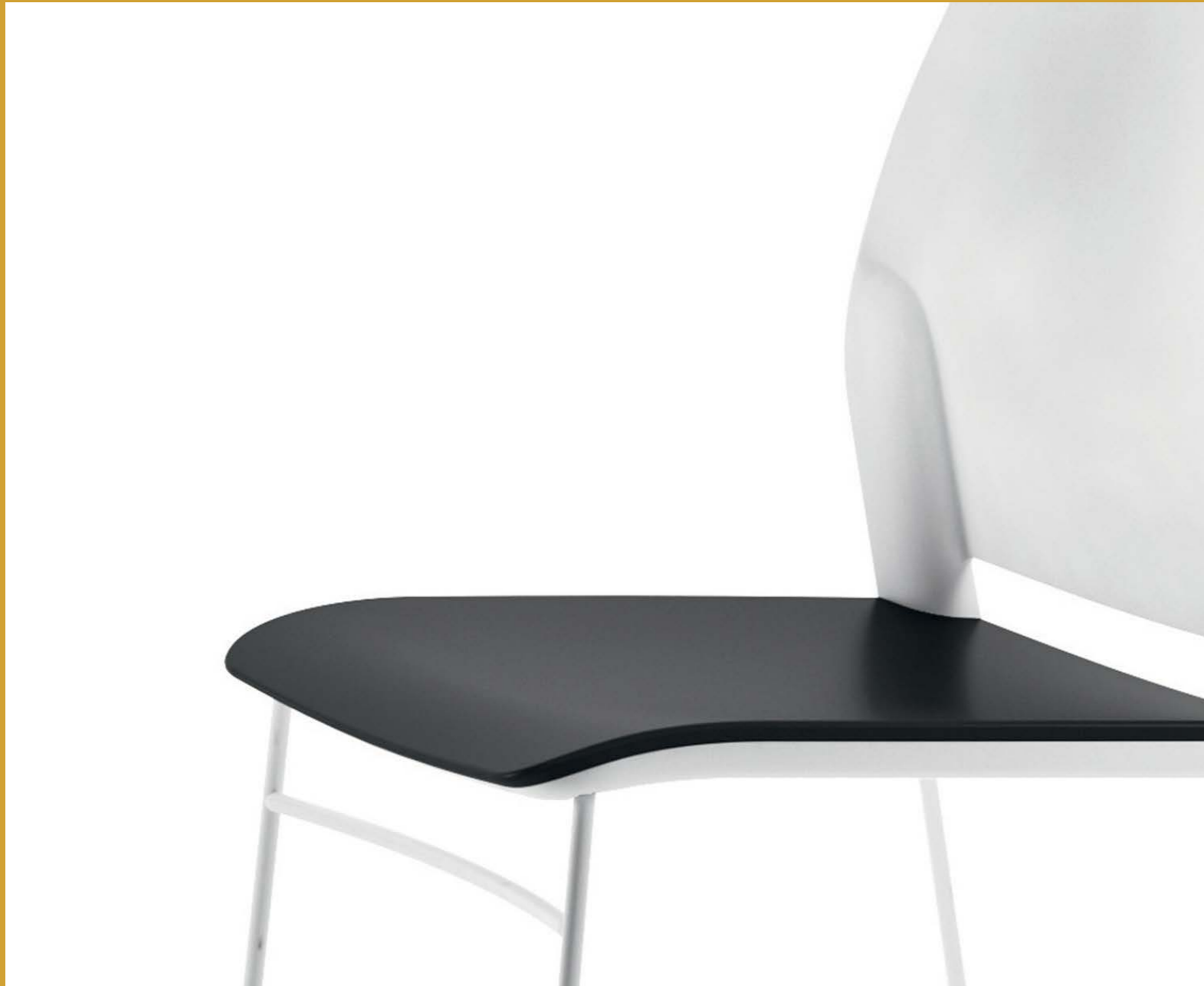

ALPHA

Baseada num casco de plástico, a família Alpha é composta por: uma versão de quatro pés, trenó, rodada, banco e tamborete. Por isso mesmo adapta-se a vários ambientes e necessidades, desde zona de espera, trabalho e conferência.

Sobre la base de su parte superior, Alpha puede estructurar una familia de asientos empezando por la silla cuatro patas, siguiendo con la silla de patín, giratoria con base a 5 puntas, taburete y bancada. Es adecuada, en fin, a diferentes necesidades del contrato, desde la función de visita hasta la de comunidad y de uso en espacios interiores abiertos.

Based on a plastic shell, the Alpha seating family is composed by: four-legged version, sled, swivel chair on a five-star base, stool and bench. It is therefore suitable for several different purposes in the contract segment, from waiting and meeting area to conference in big public spaces.

Basé sur une coque en plastique, la famille Alpha se compose de un nouveau piètement à quatre pieds, un traîneau, base avec roulette, un banc et un tabouret. Pour cette raison, il s'adapte à divers environnements et besoins, depuis l'espace d'attente, de travail et de conférence.













Dados Técnicos | Technical Data | Datos Tecnicos | Données Techniques

Alpha.1

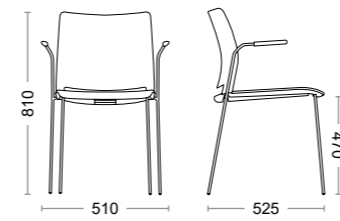

Alpha.2

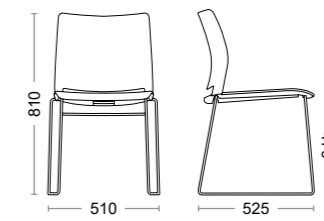

Alpha.3

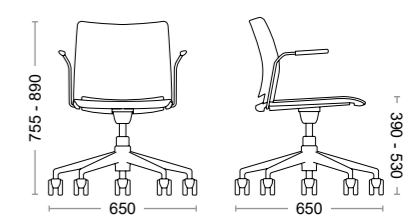

Alpha.4

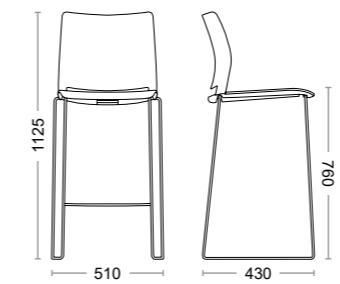

Alpha.5

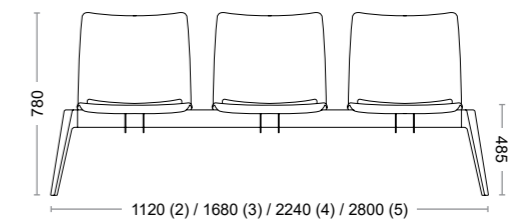

Corpo - Body - Cuerpo - Corps



Estrutura - Frame - Estructura - Structure





MULTY

A Multy é uma solução ideal tanto para o escritório como para zonas de espera, reunião ou conferências. Para além do conforto, a Multy possui outras características, a sua funcionalidade versátil combina com a resistência e segurança em conformidade com os padrões internacionais.

Multy es una solución ideal tanto para la oficina como para zonas de espera, reuniones o conferencias. Además de la comodidad, Multy tiene otras características, su funcionalidad versátil se combina con la resistencia y la seguridad de acuerdo con los estándares internacionales.

Multy is an ideal solution both for office and for contract environments, as waiting, meeting and conference areas. Besides comfort Multy has got other features: its versatile functionality combines with resistance and reliability in compliance with the international standards.

Multy est une solution idéale pour les bureaux, les salles d'attente, réunion ou de conférence. En plus du confort, le Multy possède d'autres fonctionnalités, sa fonctionnalité polyvalente combine résistance et sécurité en conformité avec les normes internationales.



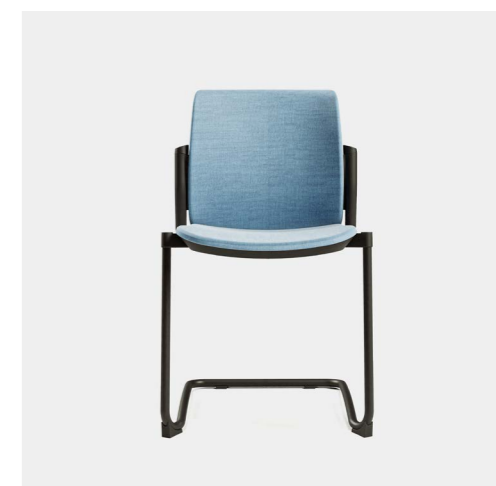







Dados Técnicos | Technical Data | Datos Tecnicos | Données Techniques

Multy.1

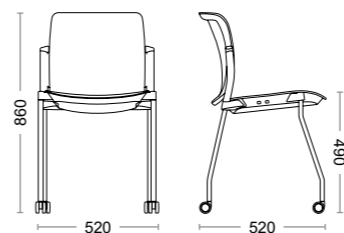

Multy.2

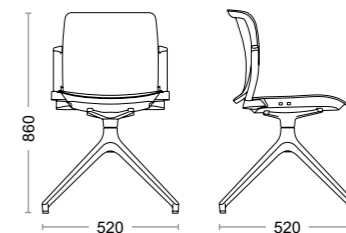

Multy.3

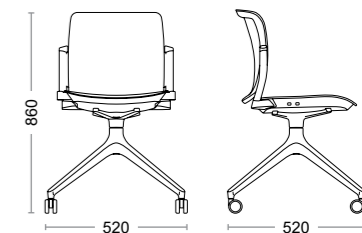

Multy.4

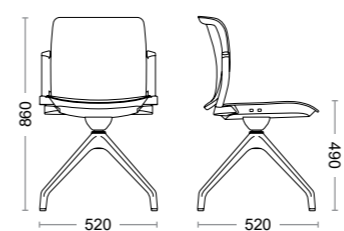

Multy.5

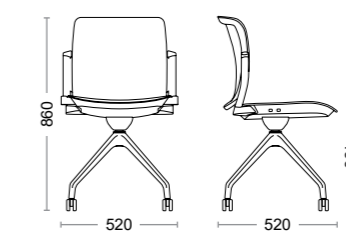

Multy.6

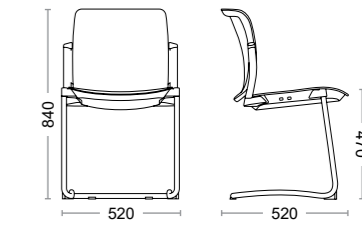

Multy.7

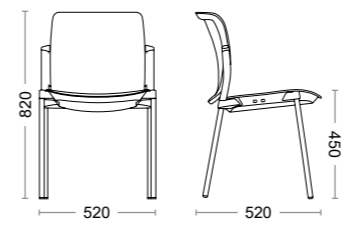

Estrutura - Frame - Estructura - Structure



RAL 9005

Preto
Black
Negro
Noir



RAL 9003

Branco
White
Blanco
Blanc



RAL 7012

Cinza
Grey
Gris
Gris



Cromado
Chrome
Cromado
Chromé

Corpo - Body - Cuerpo - Corps



RAL 9005

Preto
Black
Negro
Noir



RAL 9003

Branco
White
Blanco
Blanc



DREAM

A característica de poder empilhá-las com facilidade e os acessórios como palmatória, o elo de ligação e o carrinho de transporte, fazem dela um produto funcional capaz de satisfazer qualquer tipo de necessidade.

La posibilidad de ser fácilmente apilable y los accesorios como la tabla de escritura, la varilla de unión y la carretilla de transporte, la hacen un producto funcional capaz de satisfacer cualquier tipo de necesidades.

The ability to easily stack and the accessories, such the writing tablet, the joint coupler and the trolley, make it a functional product, capable of satisfying all kinds of needs.

La caractéristique de pouvoir empiler avec facilité et les accessoires comme appui pour écrire, le coupleur D'union et le chariot transporteur, fait d'elle un produit fonctionnel capable de satisfaire quelconque type de besoin.







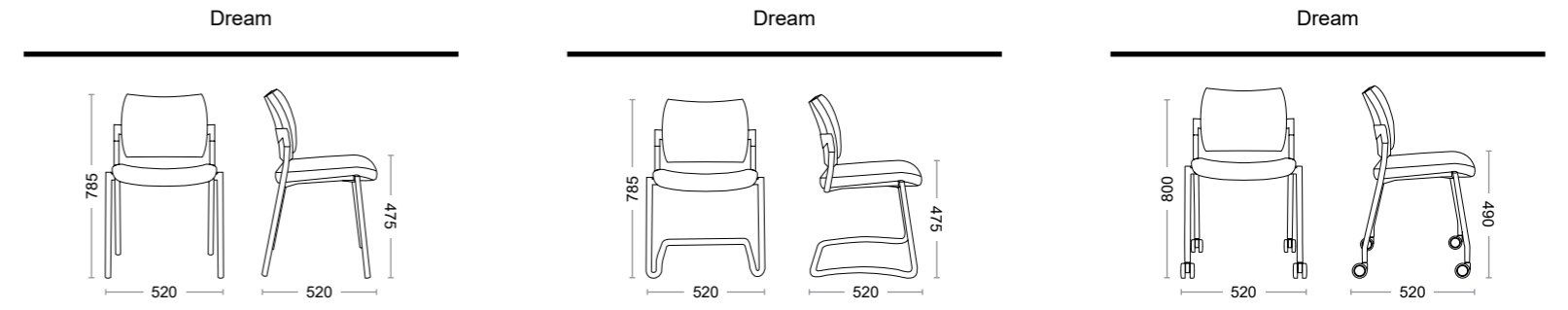

Corpo - Body - Cuerpo - Corps

RAL 9005	RAL 7045	RAL 7035	RAL 6017	RAL 3000	RAL 5003
Preto Black Negro Noir	Cinza Grey Gris Gris	Branco White Blanco Blanc	Verde Green Verde Vert	Vermelho Red Rojo Rouge	Azul Blue Azul Bleu

Estrutura - Frame - Estructura - Structure

RAL 9005		RAL 7012
Preto Black Negro Noir	Cromado Chrome Cromado Chromé	Cinza Grey Gris Gris

Externos - Outer seat - Externos - Parties Extérieures

RAL 9005	RAL 7045
Preto Black Negro Noir	Cinza Grey Gris Gris

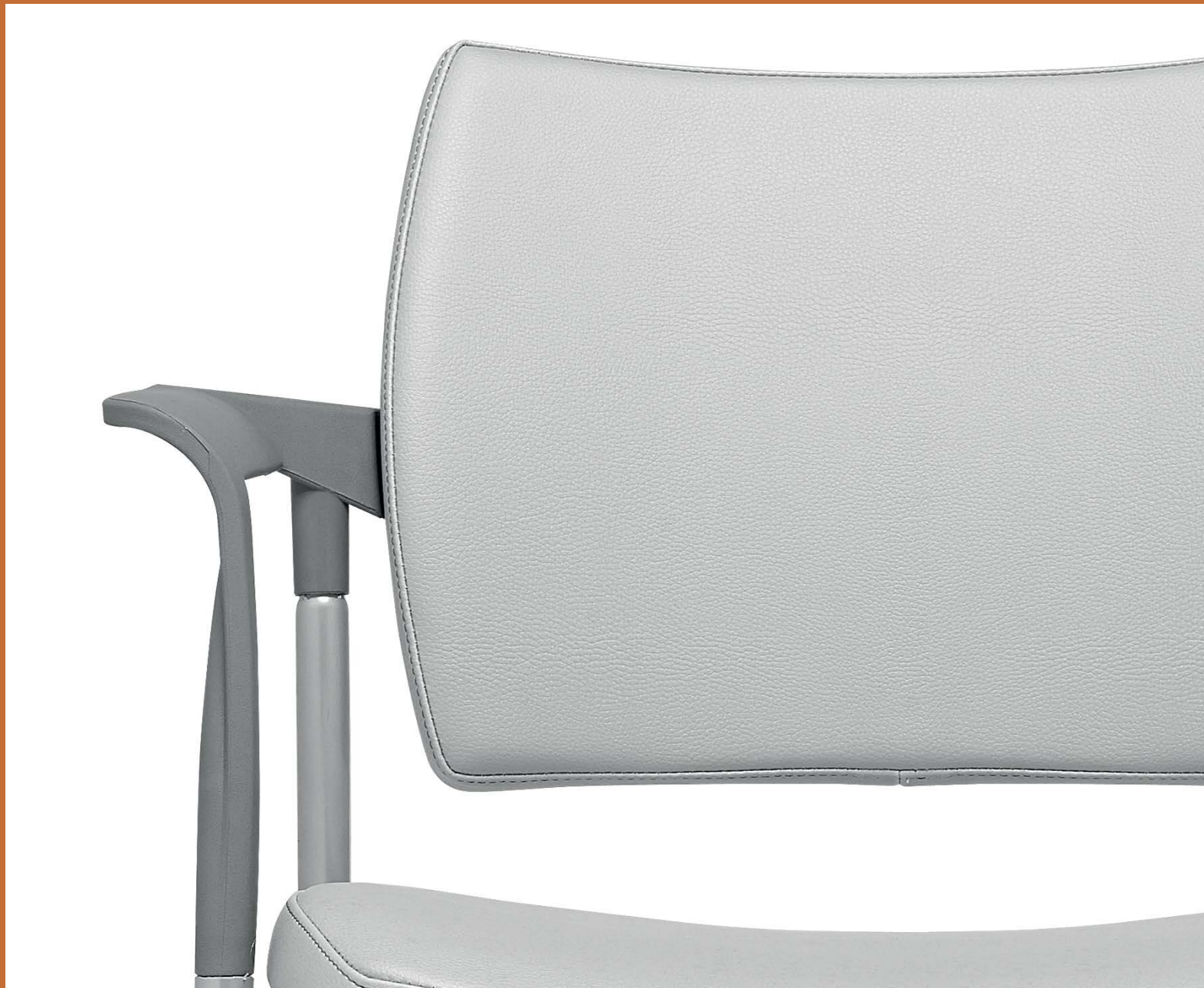

DREAM PLUS

A Dream Plus conta com uma variada gama de cores que em conjunto com o seu design transforma os ambientes.

Dream Plus cuenta con una variada gama de colores, que juntamente con su diseño, transforma los ambientes.

Dream Plus is available in a wide range of colors that together with its design, transform environments.

La Dream Plus a une grande variété de gamme de couleurs qui avec son design transforment les ambiances.





Dream Plus

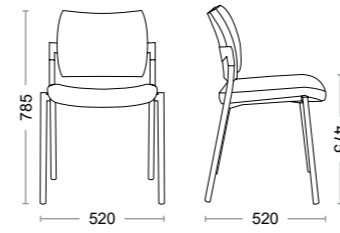

Estrutura - Frame - Estructura - Structure

- RAL 9005

Preto
Black
Negro
Noir
- Cromado
Chrome
Cromado
Chromé
- RAL 7012

Cinza
Grey
Gris
Gris

Externos - Outer seat - Externos - Parties Extérieures

- RAL 9005

Preto
Black
Negro
Noir
- RAL 7045

Cinza
Grey
Gris
Gris



NUKE

Totalmente desenvolvida em plástico, a Nuke torna-se uma cadeira extremamente simples e leve. Ideal para ambientes modernos e minimalistas, a Nuke é um modelo com duas versões (com e sem apoio de braço) e uma vasta gama de cores.

Totalmente desarrollada en plástico, Nuke se convierte en una silla extremadamente simple y ligera. Ideal para ambientes modernos y minimalistas, Nuke es un modelo con dos versiones (con y sin soporte de brazo) y una amplia gama de colores.

Completely developed in plastic, the Nuke becomes an extremely simple and light chair. Ideal for modern and minimalist environments, Nuke is a model with two versions (with and without armrest) and a wide range of colors.

Complètement développé en plastique, le Nuke devient extrêmement simple et légère. Idéal pour les environnements modernes et minimalistes, Nuke est un modèle avec deux versions (avec et sans accoudoirs) et une large gamme de couleurs.







Nuke

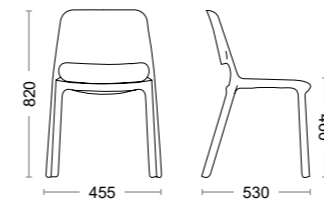

Nuke

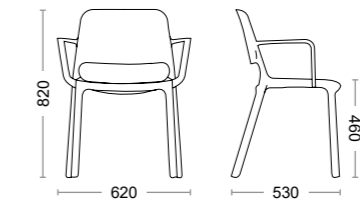

New 100% recycled plastic.
100% efficient.

Rinasco



Oceano Roccia Lava

Corpo - Body - Cuerpo - Corps

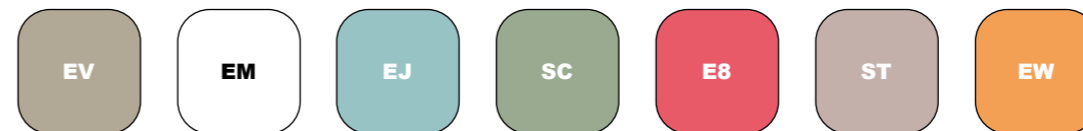

Sandy Snowball Icesurf Swamp Coral Powder Sunsplash



REVO

Revo é estilo e cor. Conjuga um carácter ligeiro e alegre com a robustez da sua estrutura. Este modelo irradia vitalidade e é produzida numa grande variedade de cores e versões.

Revo es estilo y color. Combina un carácter ligero y alegre con una estructura robusta. Este modelo irradia vitalidad y es producido en una multiplicidad de colores y versiones.

Revo is style and color. It combines a slight and joyful character with its strong structure. It radiates vitality and it's available in a wide variety of colors and versions.

Revo est un style de couleur. Conjugue un caractère léger et joyeux avec la robustesse de sa structure. Ce modèle irradie de la vitalité et est produit dans une grande variété de couleurs et versions.





Revo

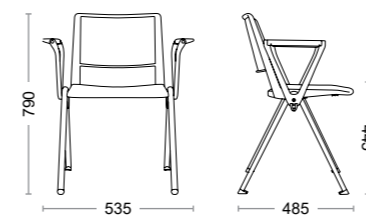

Corpo - Body - Cuerpo - Corps

POP	POB	POV	POR	POA	POG	POL	POI
Preto Black Negro Noir	Branco White Blanco Blanc	Verde Green Verde Vert	Vermelho Red Rojo Rouge	Azul Blue Azul Bleu	Cinza Grey Gris Gris	Laranja Orange Naranja Orange	Ivory

Estrutura - Frame - Estructura - Structure

RAL 9005		
Preto Black Negro Noir	Cromado Chrome Cromado Chromé	Cinza Grey Gris Gris



NEXUS

A desintegração do sofá tradicional começa a ser cada vez mais evidente, acima de tudo no que diz respeito ao espaço público. Hoje as necessidades definem-se em palavras-chave como, continuidade e modularidade. Os sofás ganham novas utilidades e tornam-se verdadeiras ferramentas de trabalho.

La desintegración del sofá tradicional es cada vez más evidente, sobre todo en lo que respecta al espacio público. Las necesidades actuales se definen en palabras clave como continuidad y modularidad. Los sofás adquieren nuevos usos y se convierten en verdaderas herramientas de trabajo.

The disintegration of the traditional sofa is becoming increasingly evident, above all with regard to public space. Today, needs are defined in keywords such as continuity and modularity. Sofas gain new uses and become true working tools, and this requires a more complex development focused.

La désintégration du canapé traditionnel devient de plus en plus évidente, surtout en ce qui concerne l'espace public. Les besoins actuels sont définis par des mots-clés tels que continuité et modularité. Les canapés gagnent de nouveaux usages et deviennent de véritables outils de travail.



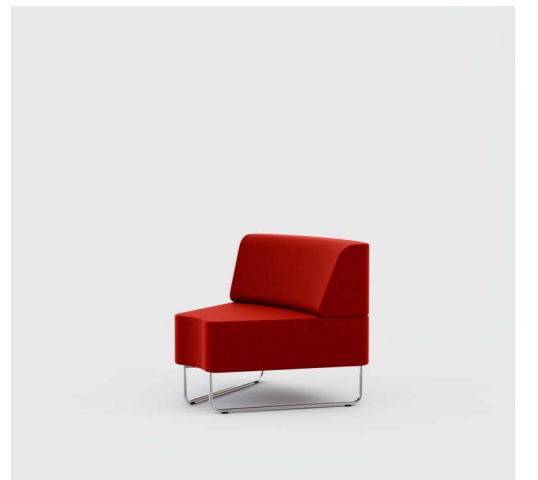
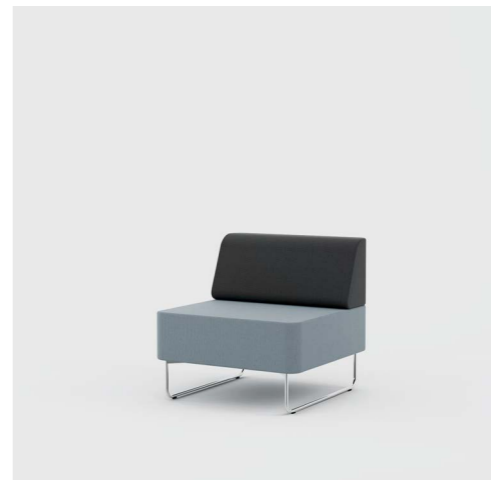





Nexus A

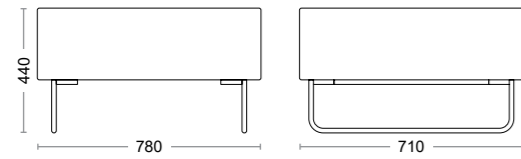

Nexus F

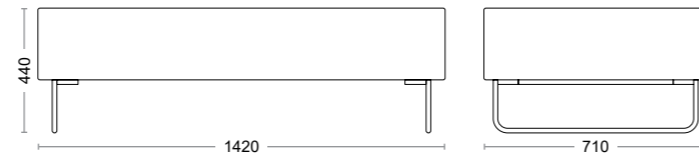

Nexus K

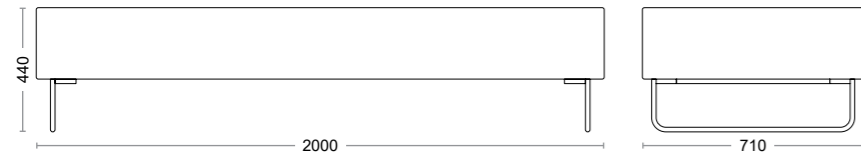

Nexus P

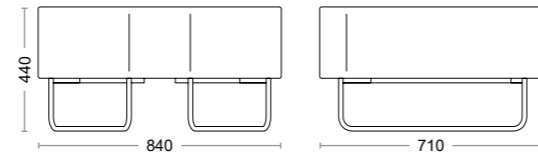

Nexus B

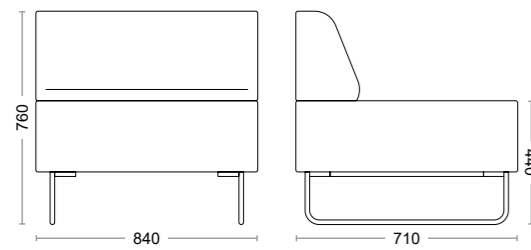

Nexus J

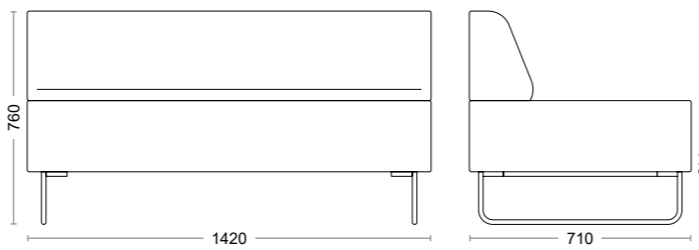

Nexus M

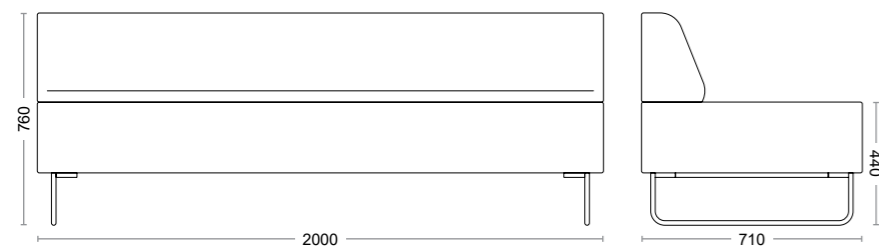

Nexus Q

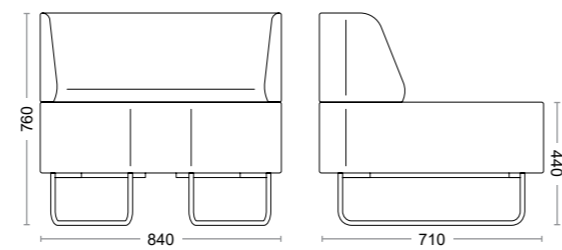

Nexus R

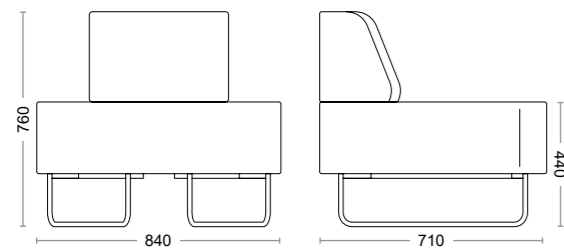

Nexus X

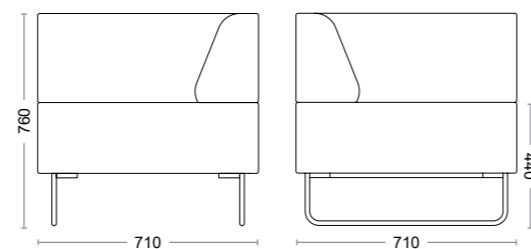

Nexus S

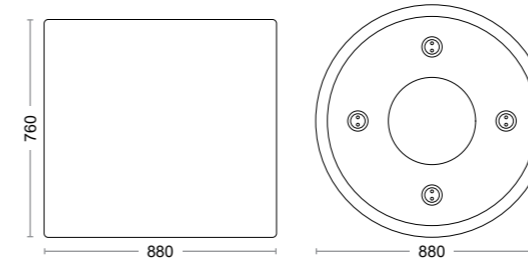

Nexus V

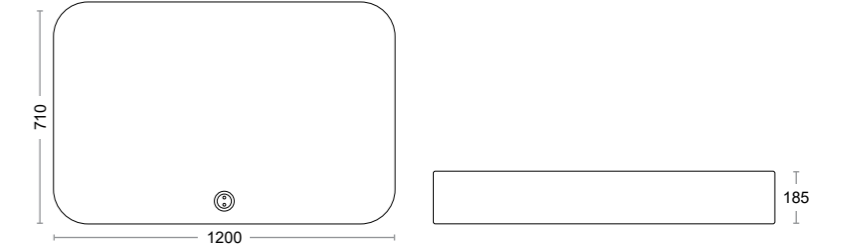

Nexus T

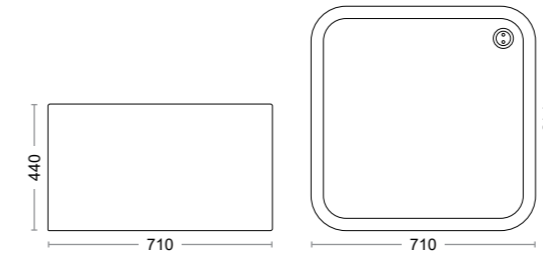

Nexus U

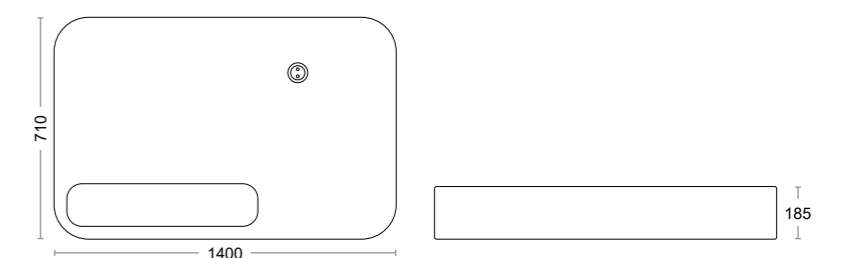

Nexus Y

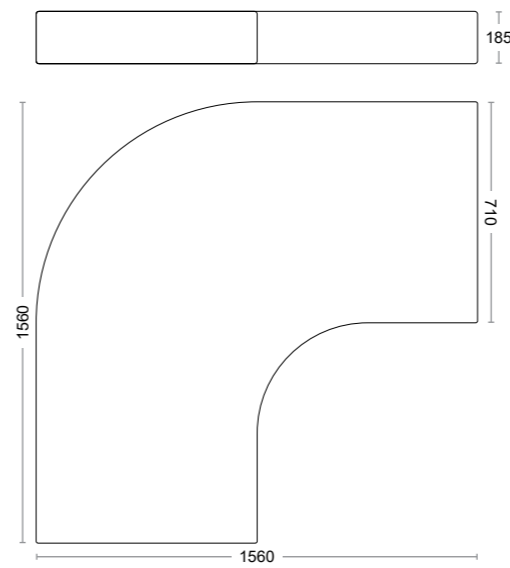



POSH

Com uma linguagem sóbria, moderna e apelativa o sistema Posh reconhece as novas necessidades e exigências de mercado. Assim, desdobra-se numa linha que consiste em oferecer uma alternativa ao sofá convencional.

Con un lenguaje sobrio, moderno y atractivo, el sistema Posh reconoce las nuevas necesidades y exigencias del mercado. Así, se desdobra en una línea que consiste en ofrecer una alternativa al sofá convencional.

With a sober, modern and appealing language the Posh system recognizes the new needs and requirements of the market. Thus, it unfolds in a line that consists of offering an alternative to the conventional sofa.

Avec un langage sobre, moderne et attrayant, le système Posh reconnaît les nouveaux besoins et exigences du marché. Ainsi, il se déroule dans une ligne qui consiste à offrir une alternative au canapé classique.





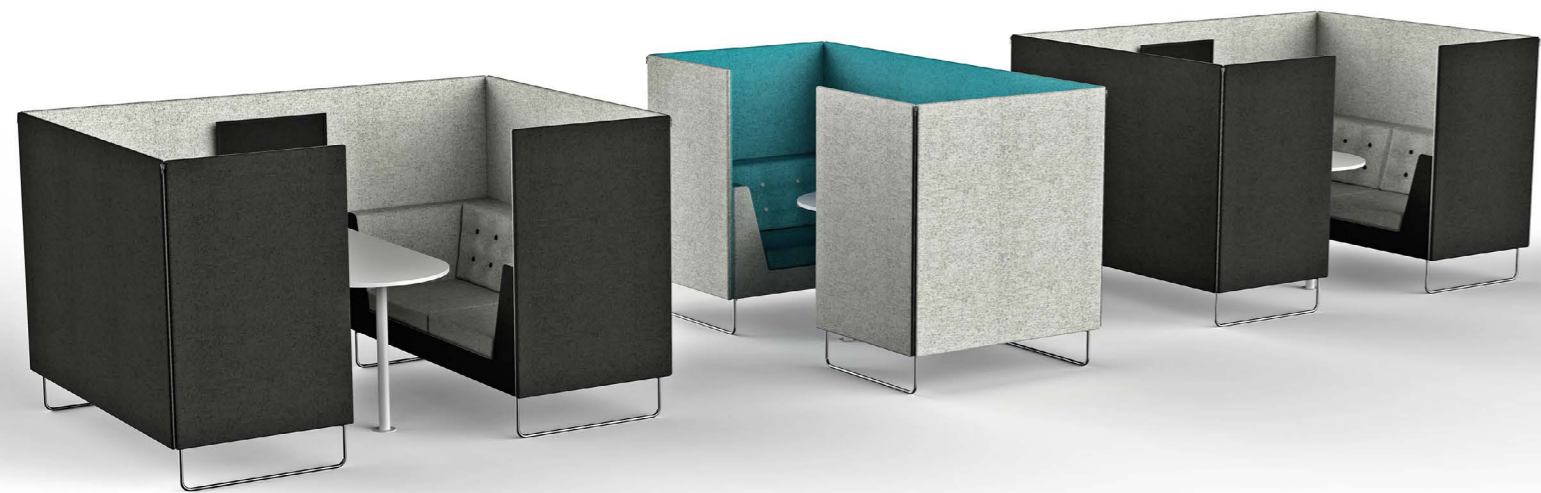





Dados Técnicos | Technical Data | Datos Tecnicos | Données Techniques

Posh

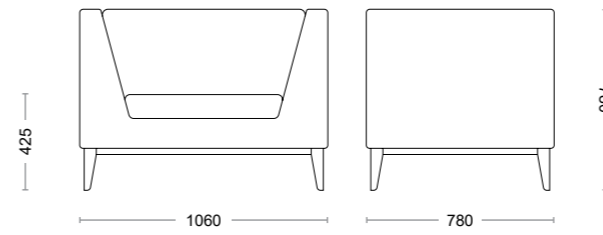

Posh

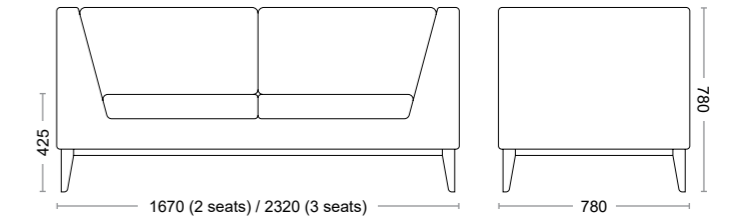

Posh CAB

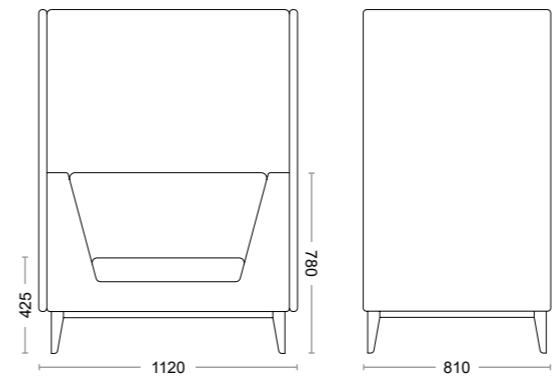

Posh CAB

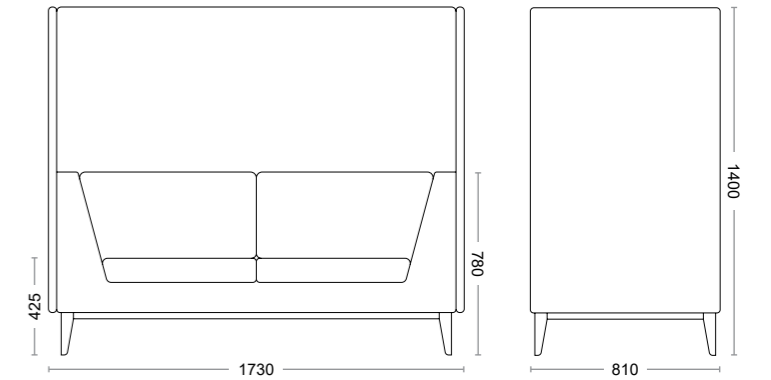

Posh Meeting

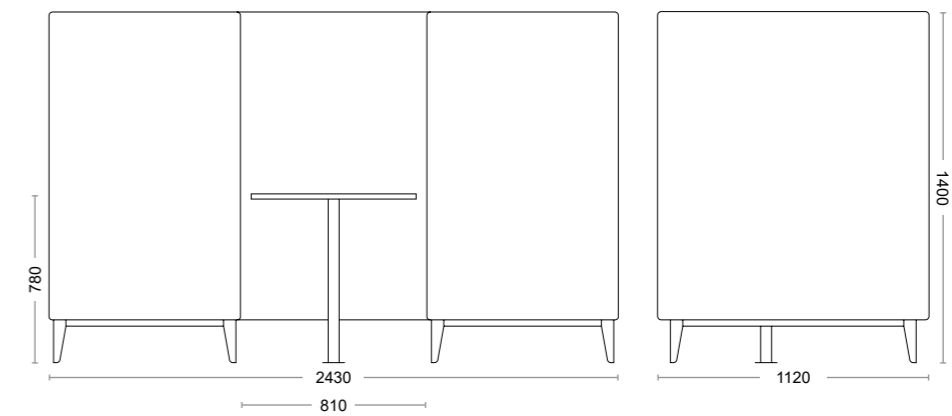

Posh Meeting

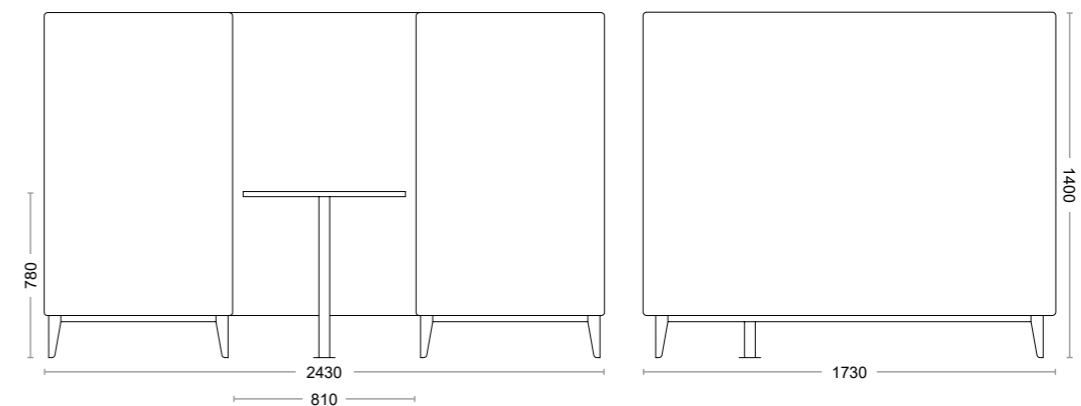



ORIGEM

Um simples cisne feito de papel promove a criatividade e a execução de uma série de sofás leve, pequena e de linhas vincadas, tal como a arte do Origami, assim surge a linha Origem.

Un simple cisne de papel promueve la creatividad y la ejecución de una serie de sofás leve, pequeña y de líneas marcadas, como el arte del Origami. Así surge la línea Origem.

A simple swan made of paper can promote creativity and the execution of a slight and small series of sofas with sharp lines, as in the Origami art, this is how the Origem line appeared.

Un simple cygne fait de papier promouvoir la créativité et l'exécution d'une série de fauteuils léger, petit et de lignes fermes, tel l'art d'Origami, ainsi surgit la ligne Origem.



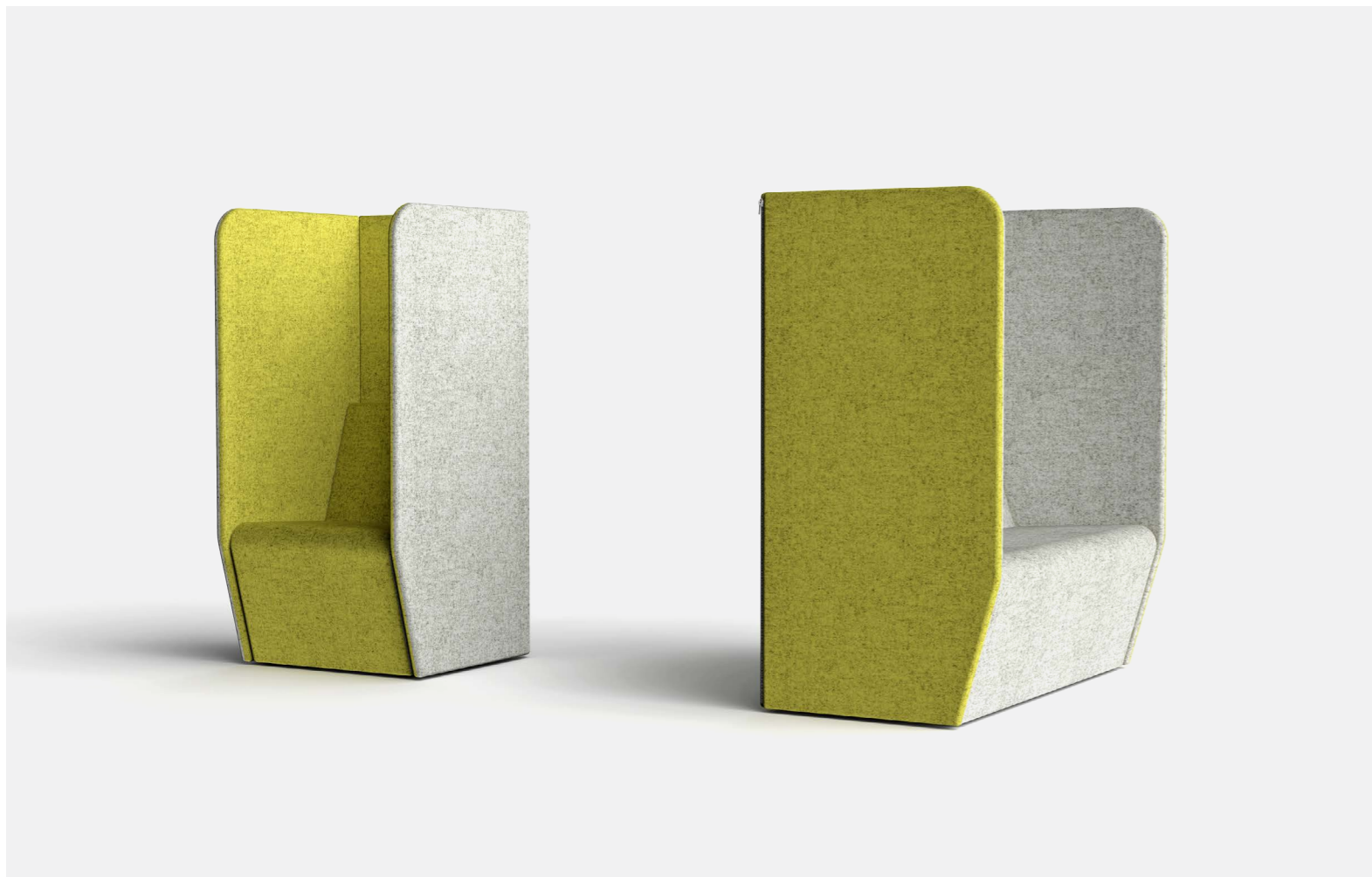

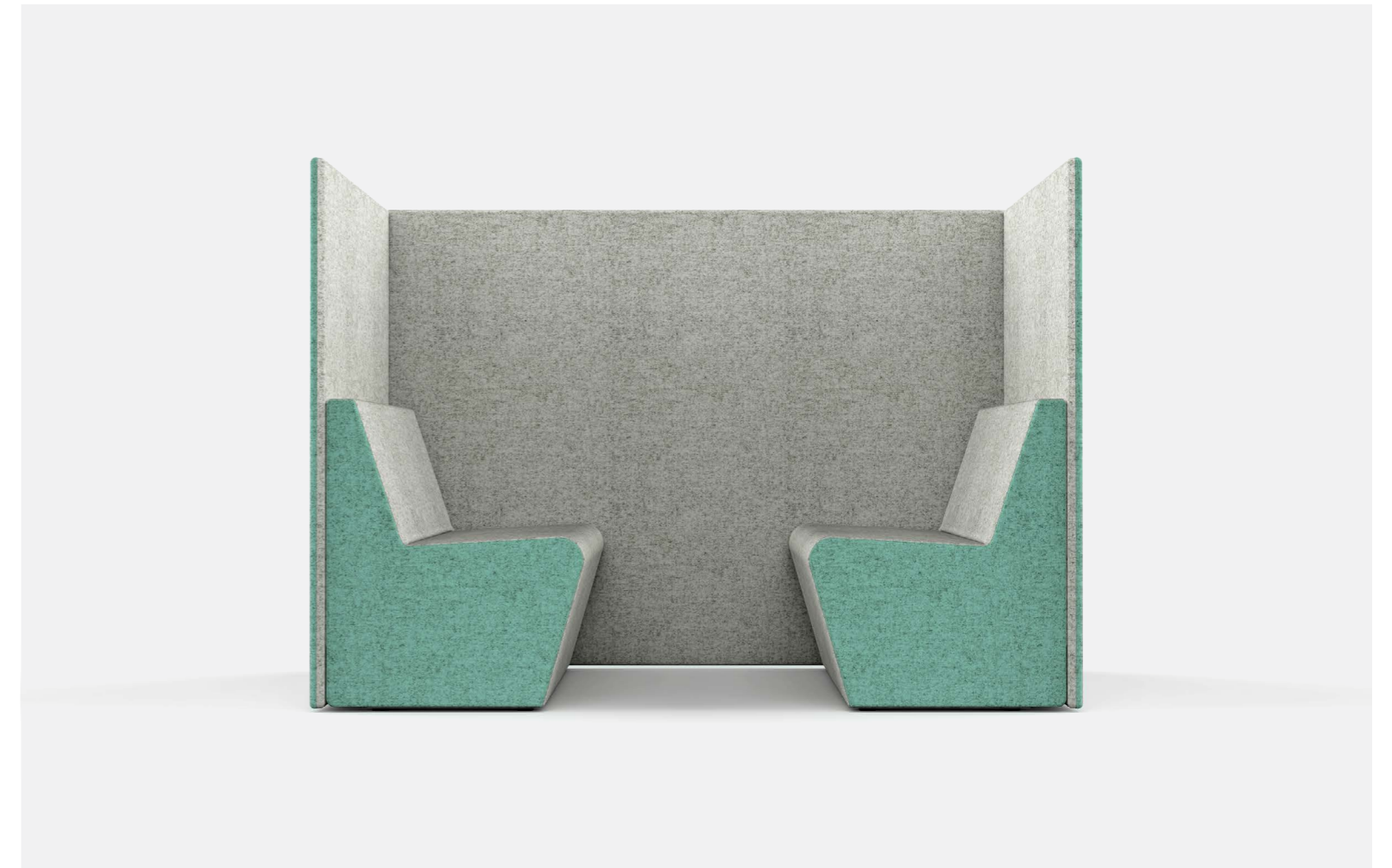



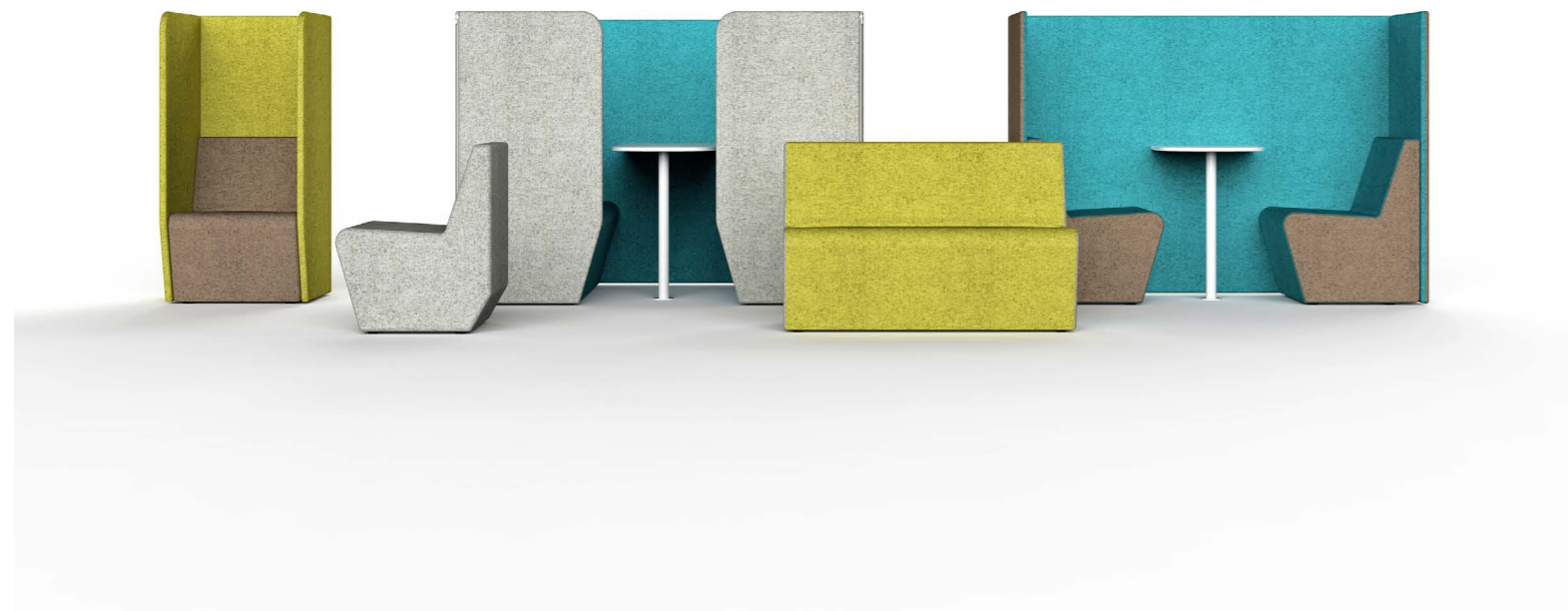

Origem

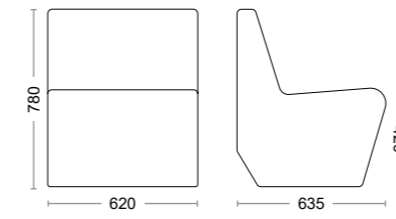

Origem

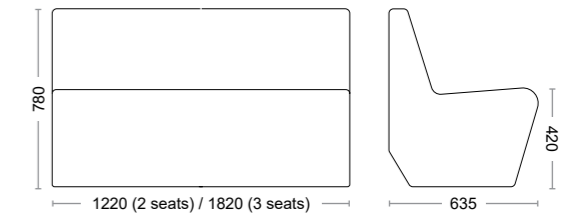

Origem CAB

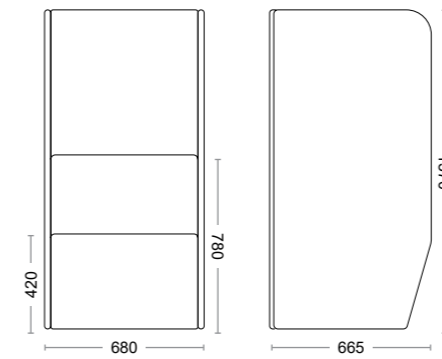

Origem CAB

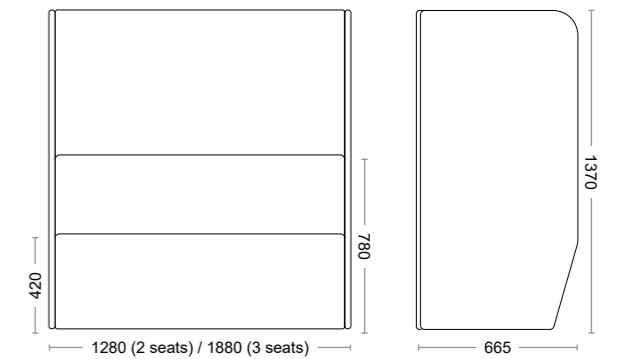

Origem Phonebooth

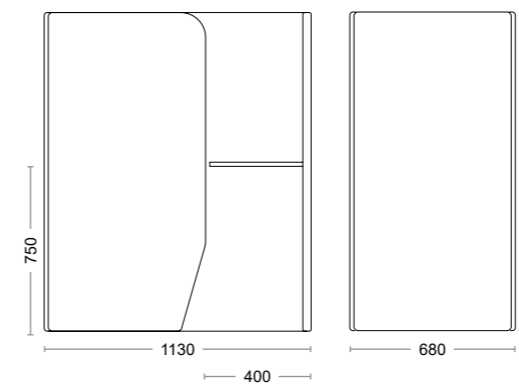

Origem Meeting

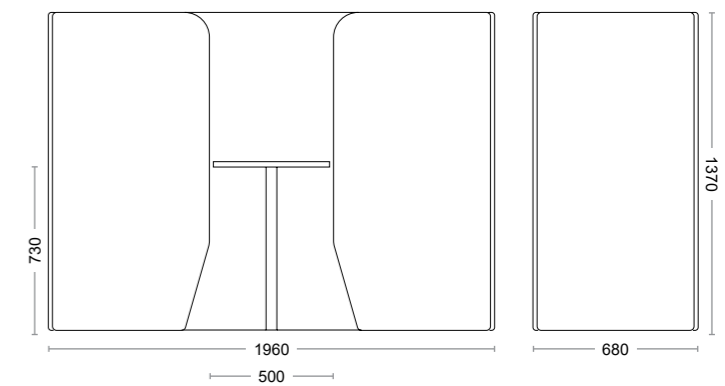

Origem Meeting

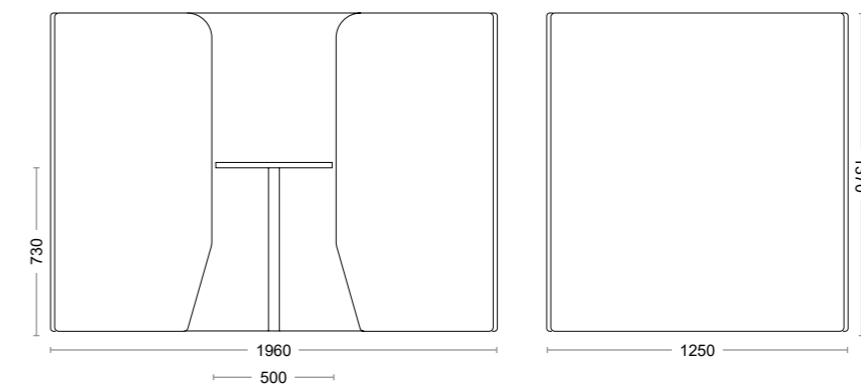



PLUG

À medida que os ambientes de trabalho vão ficando cada vez mais dinâmicos e mais amplos também se vão tornando mais barulhentos e frios. A individualidade e privacidade devem continuar a ser valorizados nos novos layouts do escritório moderno.

A medida que los entornos de trabajo se vuelven cada vez más dinámicos y amplios, también se vuelven más ruidosos y más fríos. Naturalmente, debe haber un equilibrio en todo, y la individualidad y la privacidad deben continuar siendo valoradas en los nuevos diseños de la oficina moderna.

As work environments become increasingly dynamic and wider, they also become noisier and colder. Naturally, there must be a balance in everything, and individuality and privacy must continue to be valued in the new layouts of modern offices.

À mesure que les environnements de travail deviennent plus dynamiques et plus vastes, ils deviennent également plus bruyants et plus froids. Naturellement, il doit y avoir un équilibre entre tout, l'individualité et la vie privée doivent continuer à être valorisées dans les nouvelles dispositions du bureau moderne.



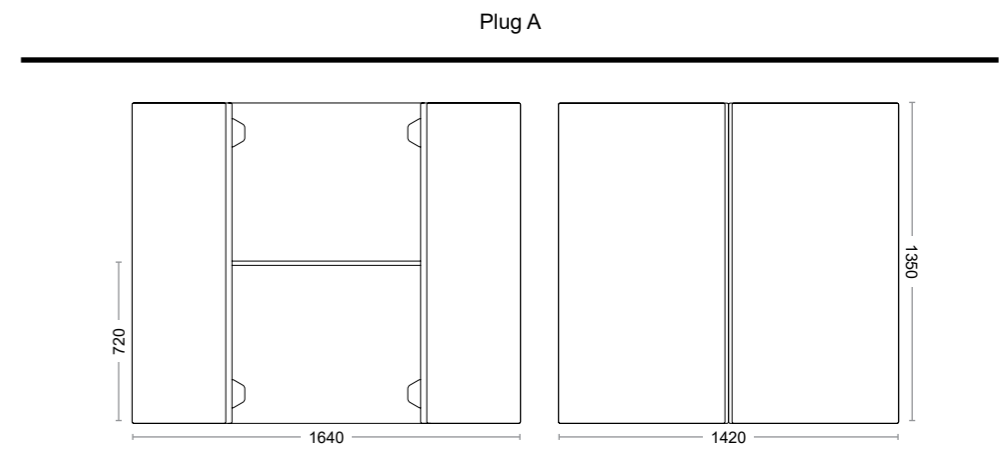
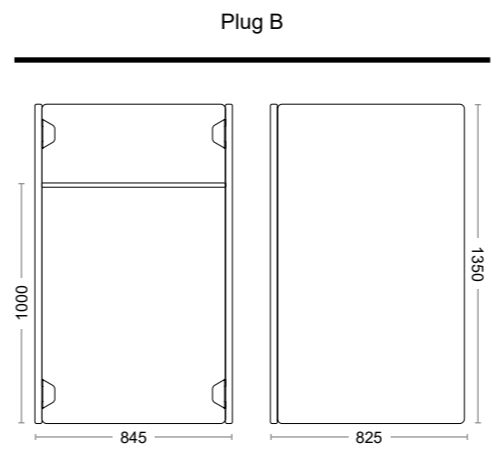
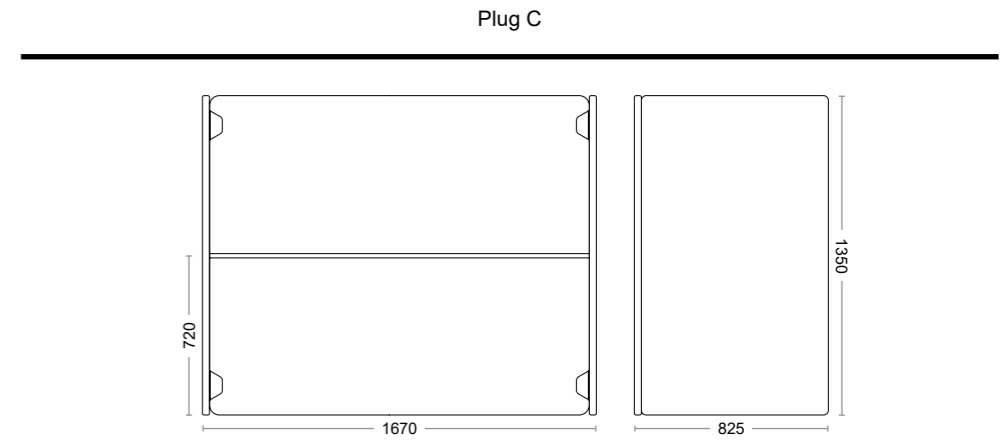
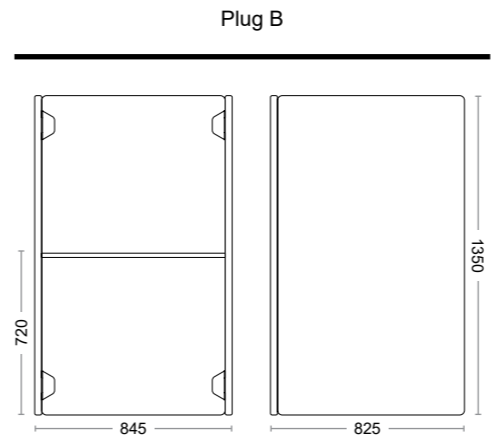



CITY

Somos, por natureza, um ser social, sendo que passamos mais tempo juntos do que sozinhos no espaço de trabalho. Contudo, ainda trabalhamos em ambientes fechados e tradicionais que desmotivam a participação ativa.

Somos, por natureza, un ser social, y pasamos más tiempo juntos que solos en el espacio de trabajo. Sin embargo, aún trabajamos en entornos cerrados y tradicionales que desalientan la participación activa.

We are, by nature, a social being, and we spend more time together than alone in the workspace. However, we still work in closed and traditional environments that discourage active participation.

Nous sommes, par nature, un être social, et nous passons plus de temps ensemble que seuls dans l'espace de travail. Cependant, nous travaillons toujours dans des environnements fermés et traditionnels qui découragent la participation active.

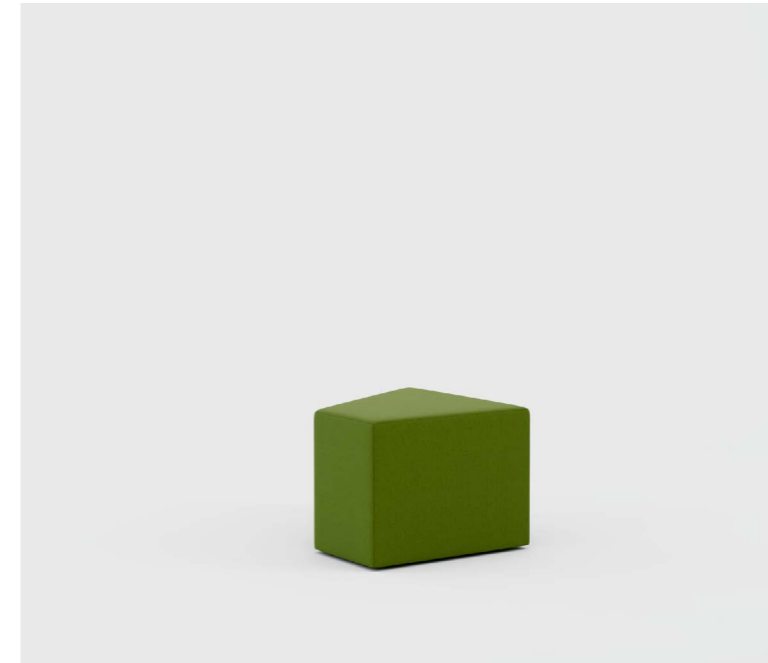









Dados Técnicos | Technical Data | Datos Tecnicos | Données Techniques

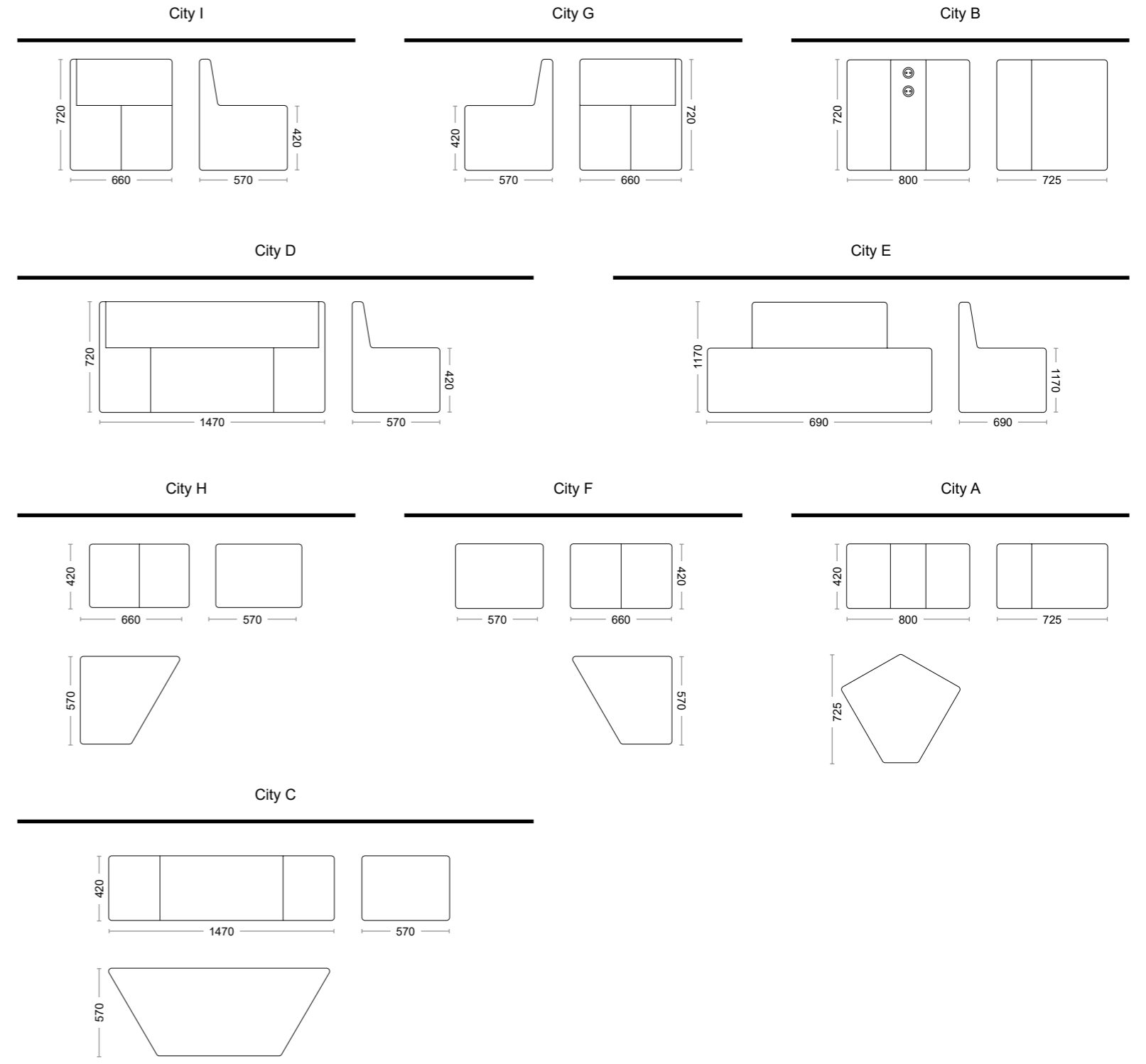



DONNA

Donna é uma poltrona contemporânea com um design tradicional e linhas elegantes. Proporciona máximo conforto e confere estilo e requinte a qualquer espaço.

Donna es una poltrona contemporánea con un diseño tradicional y líneas elegantes. Proporciona máximo confort y añade estilo y refinamiento a cualquier espacio.

Donna is a contemporary armchair with traditional design and elegant lines. Provides maximum comfort, giving style and refinement to any space.

Donna est un fauteuil contemporain avec une design traditionnelle et lignes élégantes. Fournit un maximum de confort et donne style et élégance à tout espace.







Dados Técnicos | Technical Data | Datos Tecnicos | Données Techniques

Donna

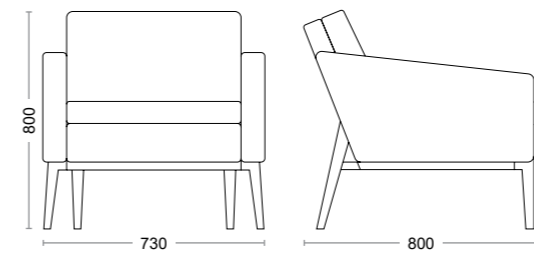

Donna

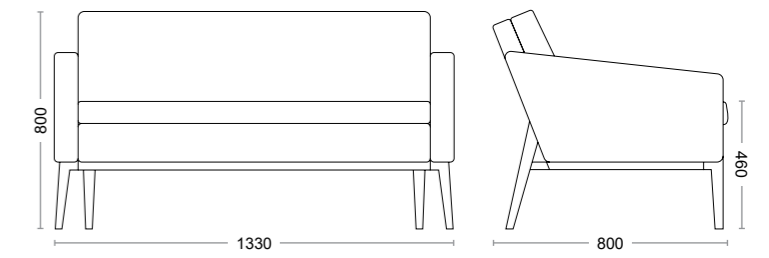

Donna

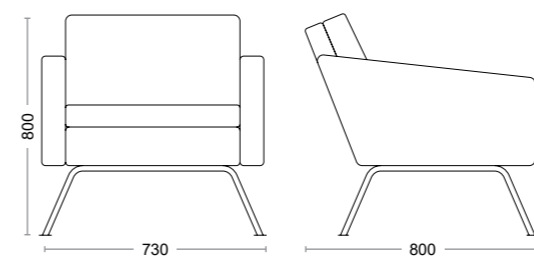

Donna

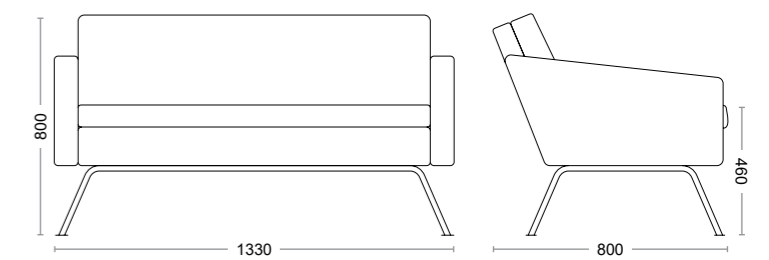

Donna

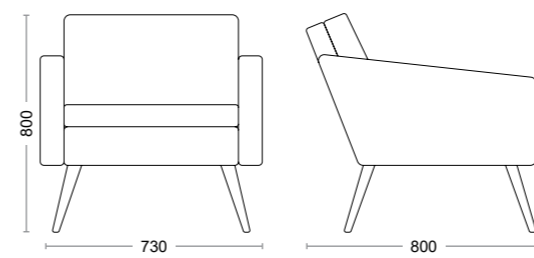



QUADRATA

Inspirada nas estruturas de reforço típicas na construção civil, a poltrona Quadrata resume-se a um conjunto de quatro almofadas soltas abraçadas por uma estrutura minuciosamente desenvolvida em barra metálica.

Inspirada en las estructuras de refuerzo típicas en la construcción civil, el sillón Quadrata se resume a un conjunto de cuatro cojines sueltos abrazados por una estructura minuciosamente desarrollada en barra metálica.

Inspired by the reinforcement structures typical of civil construction, the Quadrata armchair boils down to a set of four loose cushions hugged by a carefully crafted metal bar structure.

Inspiré par les structures de renforcement typiques de la construction civile, le fauteuil Quadrata se résume à un ensemble de quatre coussins embrassés par une structure de barre métallique soigneusement conçue.



Quadrata

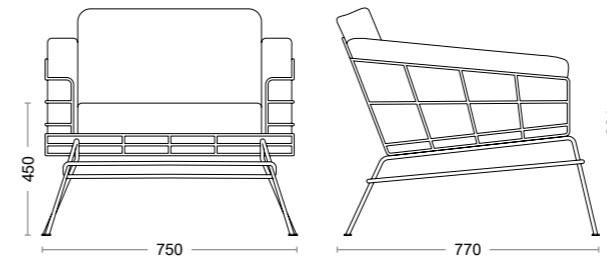



MUSH

A combinação entre módulos tem bastante versatilidade, permitindo configurações mais lineares e geométricas, mas também soluções mais aleatórias e dispersas. A sua utilidade também pode ser bastante explorada, podendo tornar-se numa mesa de centro, numa zona de espera ou num pequeno espaço de trabalho.

La combinación de módulos es bastante versátil, lo que permite configuraciones más lineales y geométricas, pero también soluciones más aleatorias y dispersas. Su utilidad también se puede explotar en gran medida y puede convertirse en una mesa de café, un área de espera o un pequeño espacio de trabajo.

The combination between modules is quite versatile, allowing for more linear and geometric configurations, but also more random and dispersed solutions. Its utility can also be greatly exploited and can become a coffee table, a waiting area or a small workspace.

La combinaison de modules est assez polyvalente, permettant des configurations plus linéaires et géométriques, mais également des solutions plus aléatoires et dispersées. Son utilité peut également être grandement exploitée et peut devenir une table basse, une salle d'attente ou un petit espace de travail.





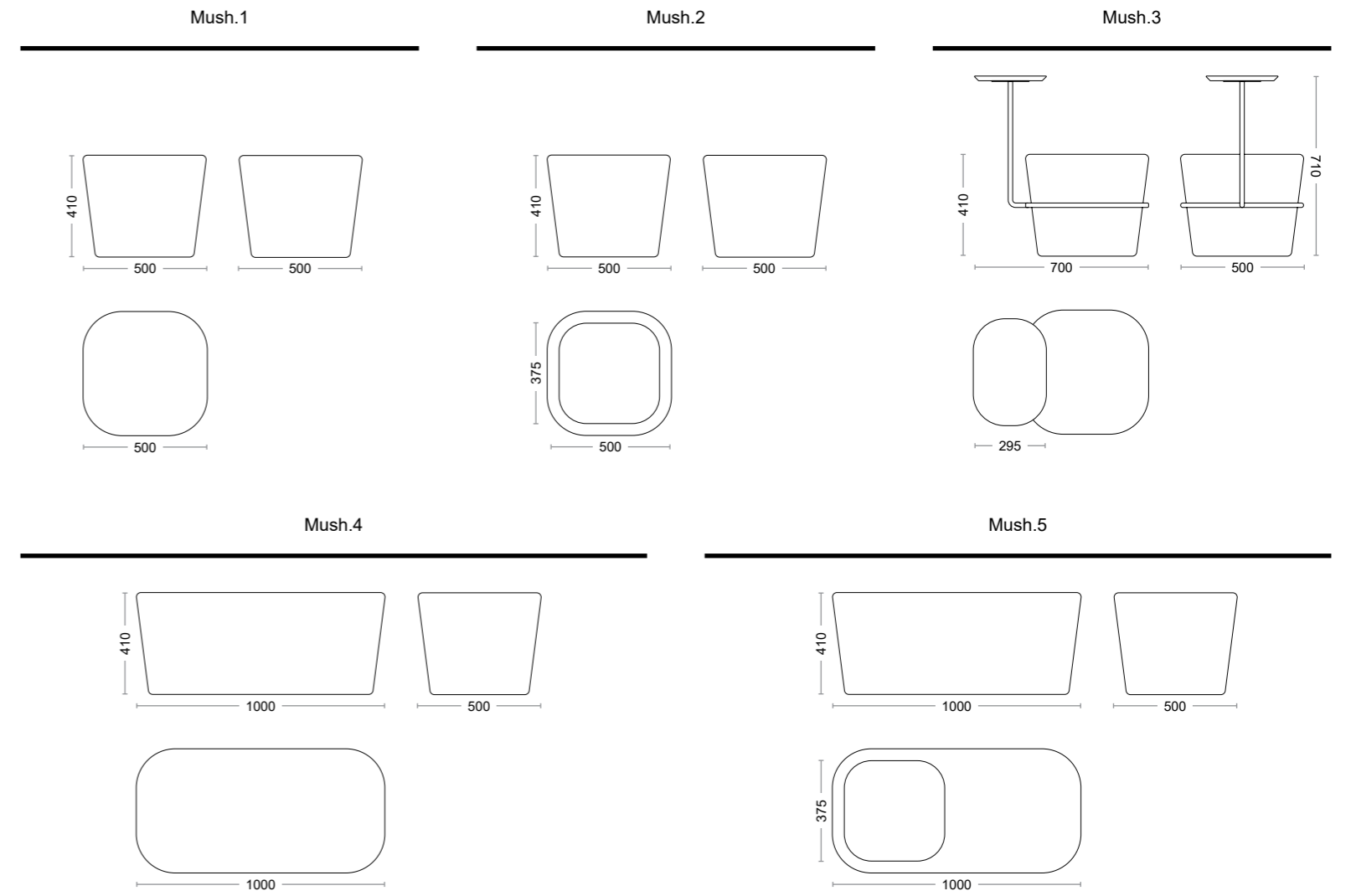



VINCO

Inspirado na arquitetura moderna e nas suas linhas arrojadas cada vez mais impressionantes, o Vinco é um sofá que pretende reivindicar a vantagem em cruzar o design com o conhecimento de outras disciplinas.

Inspirado en la arquitectura moderna y en sus líneas arrojadas cada vez más impresionantes, el Vinco es un sofá que pretende reivindicar la ventaja en cruzar el diseño con el conocimiento de otras disciplinas.

Inspired by modern architecture and its increasingly impressive bold lines, the Vinco is a sofa that claims to have the advantage of crossing the design with the knowledge of other disciplines.

Inspiré par l'architecture moderne et c'est de plus en plus impressionnant lignes vives, le Vinco est un canapé qui prétend avoir l'avantage de traverser le design avec la connaissance d'autres disciplines.





Dados Técnicos | Technical Data | Datos Tecnicos | Données Techniques

Vinco

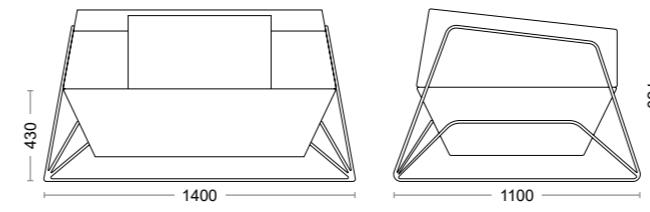

Vinco

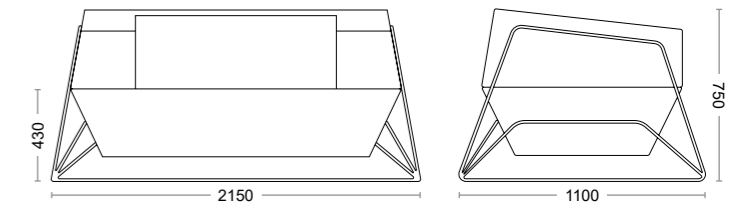



WAIT XL

Wait XL é o resultado de um projeto moderno e ergonómico criado pela Cadeinor. A sua versatilidade reflete um design funcional, adaptando-se assim a cada ambiente, a cada arquitetura de uma forma diferente e vanguardista.

Wait XL es el resultado de un diseño moderno y ergonómico creado por Cadeinor. Su versatilidad refleja un diseño funcional, adaptándose así a cada entorno, a cada arquitectura de forma diferente y vanguardista.

Wait XL is the result of a modern and ergonomic project, created by Cadeinor. Its versatility reflects a functional design, and it can adapt to any environment and architecture in a different and avant-garde style.

Wait XL est le résultat d'un projet moderne et ergonomique créé par Cadeinor. Sa versatile reflète un design fonctionnel, s'adaptant ainsi à chaque ambiance, à chaque architecture de forme différente et avant-garde.







Dados Técnicos | Technical Data | Datos Tecnicos | Données Techniques

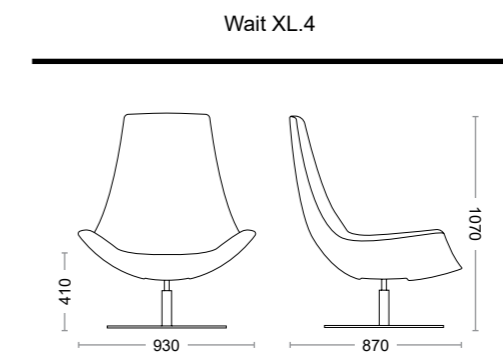
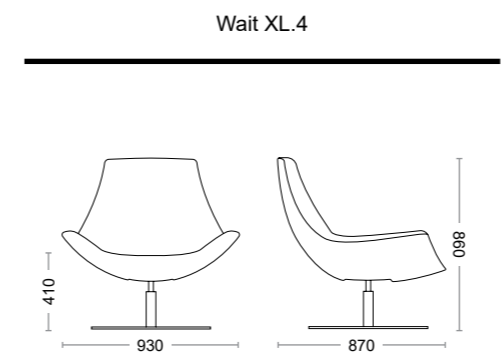
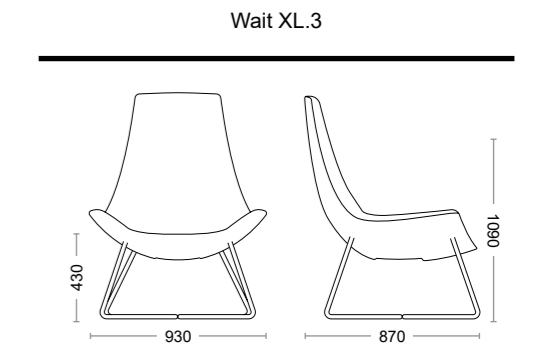
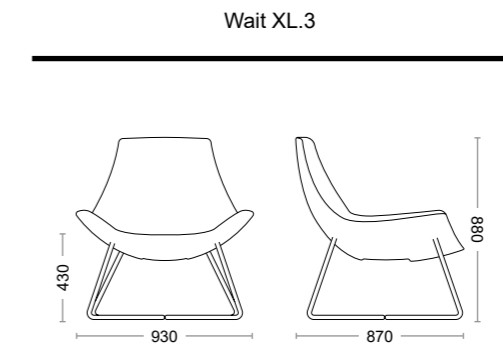
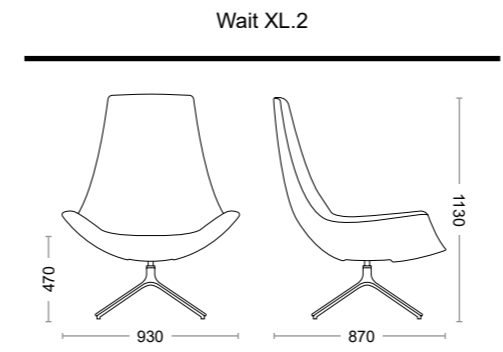
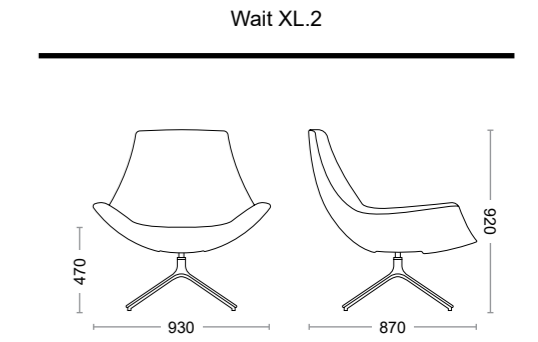
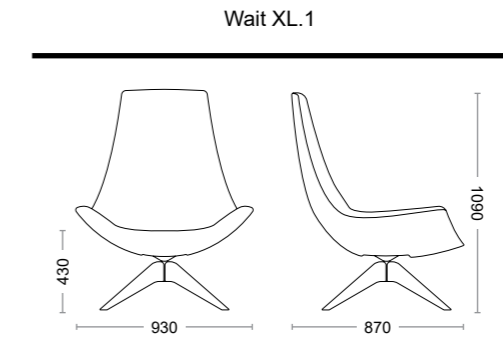
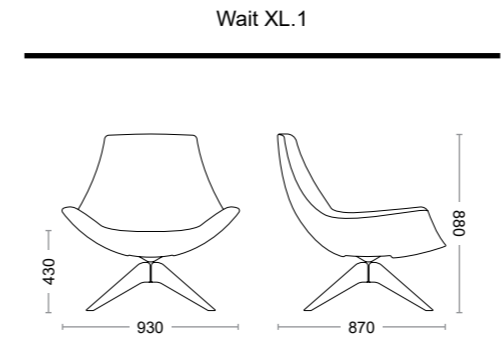



WAIT XS

O modelo Wait XS é a evolução do Wait XL e surge da necessidade em criar soluções soft-seating para áreas lounge sem que isso se transforme num desperdício de espaço. Para além disso o produto explora materiais mais sustentáveis como a madeira e conta com um design bastante característico e icónico.

El modelo Wait XS es la evolución natural del Wait XL y surge de la necesidad de crear soluciones de soft-seat para zonas lounge sin que esto se convierta en un gran desperdicio de espacio. Además, el producto explora materiales más sostenibles como la madera y tiene un diseño muy característico e icónico.

The Wait XS model is the natural evolution of the Wait XL and arises from the need to create soft-seating solutions for lounge areas without this becoming a huge waste of space. In addition, the product explores more sustainable materials such as wood and has a very characteristic and iconic design.

Le modèle Wait XS est l'évolution naturelle du Wait XL et naît de la nécessité de créer des solutions d'assise souples pour les espaces lounge sans que cela ne devienne un gaspillage d'espace. De plus, le produit explore des matériaux plus durables comme le bois et a un design très caractéristique et iconique.



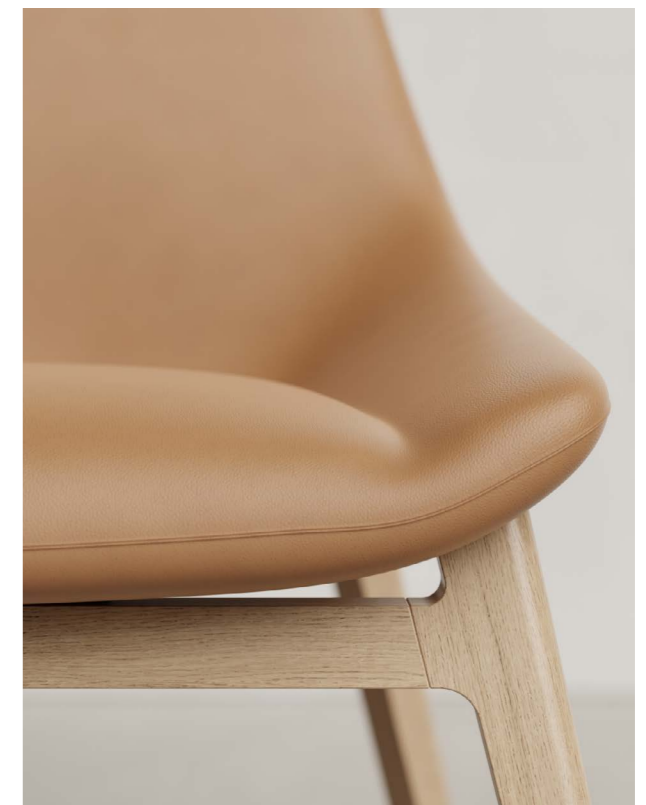





Dados Técnicos | Technical Data | Datos Tecnicos | Données Techniques

Wait XS.1

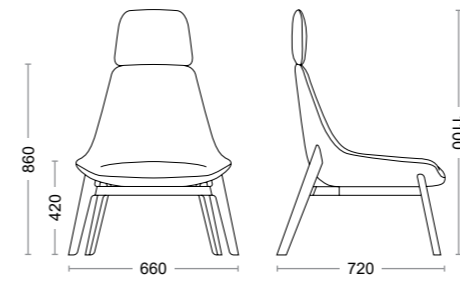

Wait XS.2

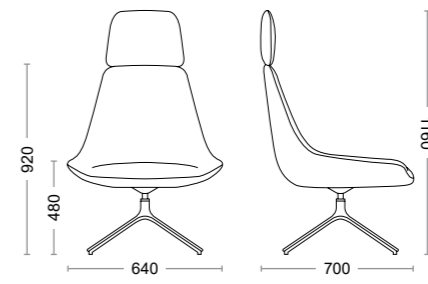

Wait XS.3

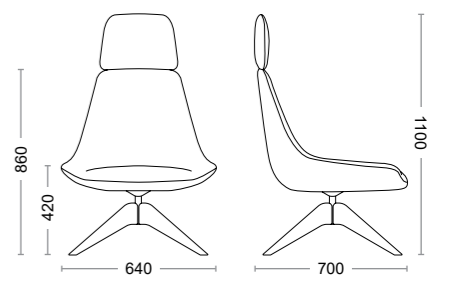

Wait XS.5

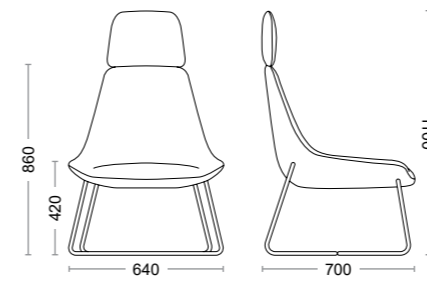



MOGLY

A Mogly surge tendo como grande referência a natureza, transparecendo essa pretensão através das suas linhas orgânicas e da representação de uma folha através de uma costura na zona de encosto.

Mogly aparece con una gran referencia a la naturaleza, mostrando esta intención a través de sus líneas orgánicas y la representación de una hoja a través de una costura en la zona trasera.

Mogly appears with a great reference to nature, showing this intention through its organic lines and the representation of a leaf through a seam in the back area.

Mogly apparaît avec une grande référence à la nature, montrant cette intention à travers ses lignes organiques et la représentation d'une feuille à travers une couture dans la zone arrière.

















Mogly XL.1

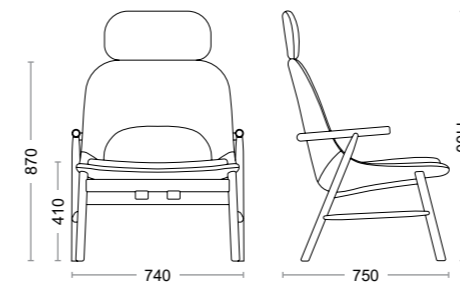

Mogly XL.2

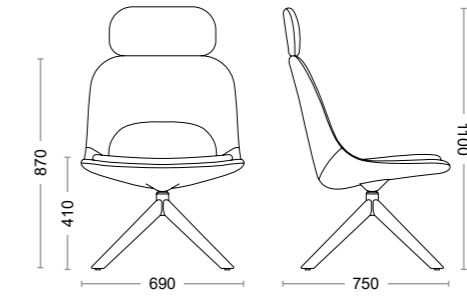

Mogly XL.3

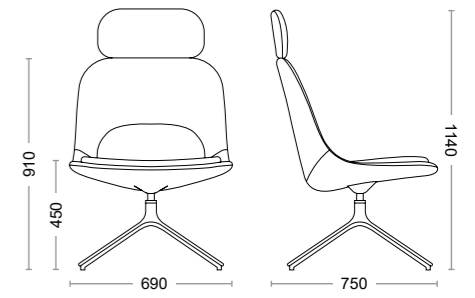

Mogly XS.1

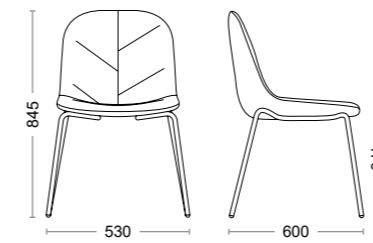

Mogly XS.2

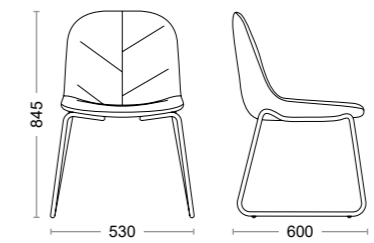

Mogly XS.3

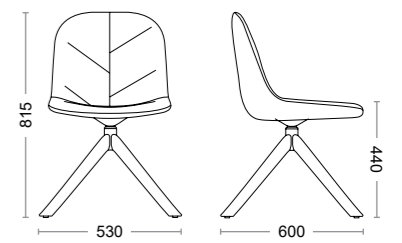

Mogly XS.4

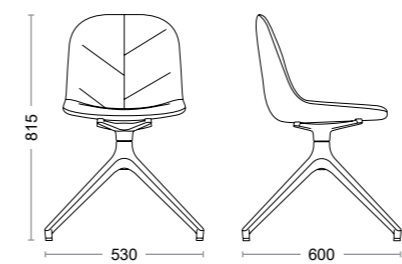

Mogly XS.5

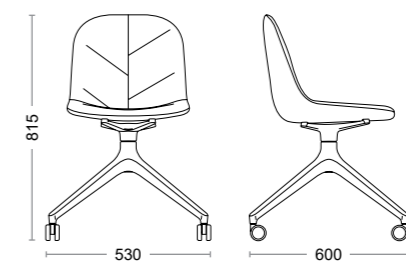

Mogly XS.6

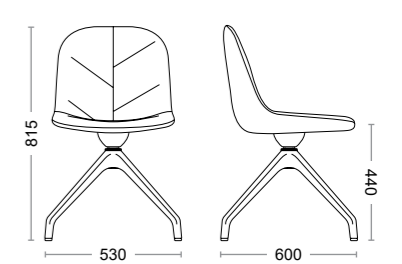

Mogly XS.7

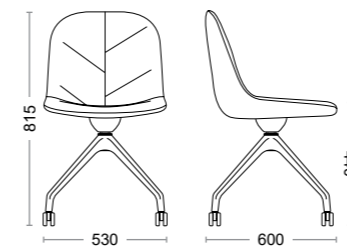



Dados Técnicos | Technical Data | Datos Tecnicos | Données Techniques

PITON

Disponível em duas alturas (alta e baixa), a mesa Piton destaca-se pela sua simplicidade. Existe ainda a possibilidade de definir formatos e dimensões para o tampo, bem como os materiais e acabamentos relativos à estrutura e tampo.

Disponible en dos alturas (alta y baja), la mesa Piton destaca por su sencillez. También existe la posibilidad de definir formatos y dimensiones para la tapa, así como los materiales y acabados relacionados con la estructura y la tapa.

Available in two heights, the Piton table stands out for its simplicity. There is also the possibility of defining formats and dimensions for the top, as well as the materials and finishes related to the structure and top.

Disponible en deux hauteurs, la table Piton se distingue par sa simplicité. Il y a aussi la possibilité de définir des formes et des dimensions pour le dessus, ainsi que les matériaux et les finitions liés à la structure et au-dessus.

Piton

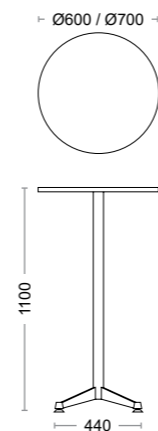

Piton

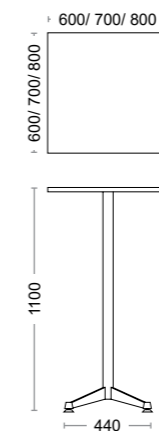

Piton

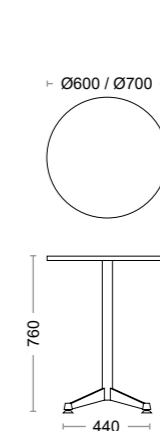

Piton

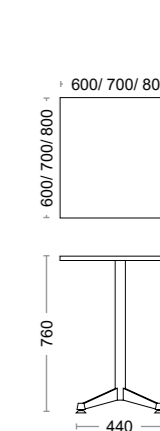



TAVO

Através das suas linhas geométricas e linguagem minimalista, a Tavo, torna-se a mesa ideal para equipar qualquer espaço. Com duas alturas standard, trata-se de um produto bastante configurável no que diz respeito aos seus acabamentos.

A través de sus líneas geométricas y lenguaje minimalista, la Tavo, se convierte en la mesa ideal para equipar cualquier espacio. Con dos alturas estándar, se trata de un producto bastante configurable en lo que se refiere a sus acabados.

Through its geometric lines and minimalist language, the Tavo, becomes the ideal table to equip any space. With two standard heights, it is a very configurable product with regard to its finishes.

Par ses lignes géométriques et son langage minimaliste, le Tavo devient la table idéale pour équiper n'importe quel espace. Avec deux hauteurs standard, c'est un produit très configurable en ce qui concerne ses finitions.

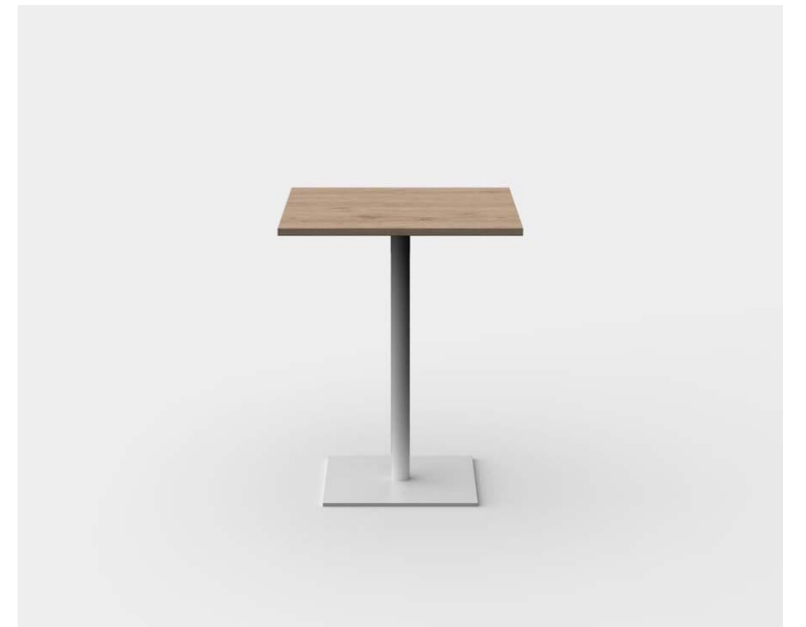

Dados Técnicos | Technical Data | Datos Tecnicos | Données Techniques

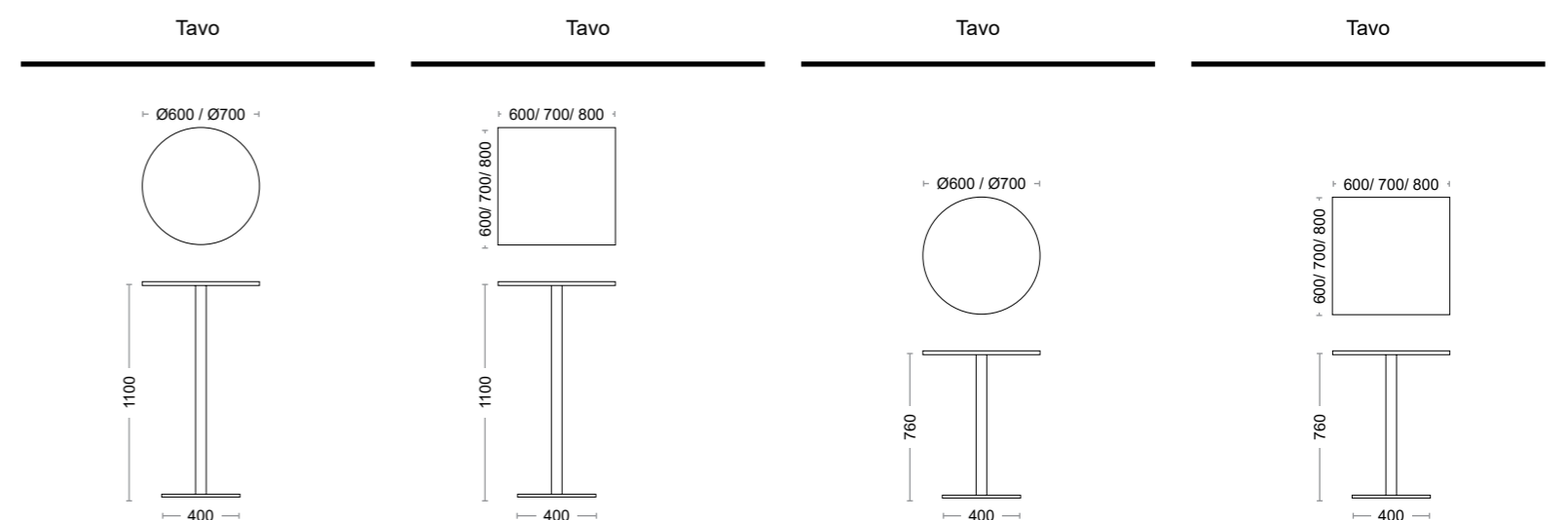



POWER TAB

Apesar da comunicação fluir de forma mais natural o ruído torna-se um fator indesejado, para isso são necessárias soluções acústicas que através da sua forma e composição material sejam capazes de absorver estes impactos.

Aunque la comunicación fluye de una manera más natural, el ruido se convierte en un factor no deseado, para esto se necesitan soluciones acústicas que a través de su forma y composición del material puedan absorber estos impactos.

Although communication flows in a more natural way, noise becomes an unwanted factor, for this acoustic solution are needed that through their shape and material composition are able to absorb these impacts.

Bien que la communication s'écoule d'une manière plus naturelle, le bruit devient un facteur indésirable, car il faut des solutions acoustiques qui, grâce à leur forme et à leur composition matérielle, soient capables d'absorber ces impacts.





Dados Técnicos | Technical Data | Datos Tecnicos | Données Techniques

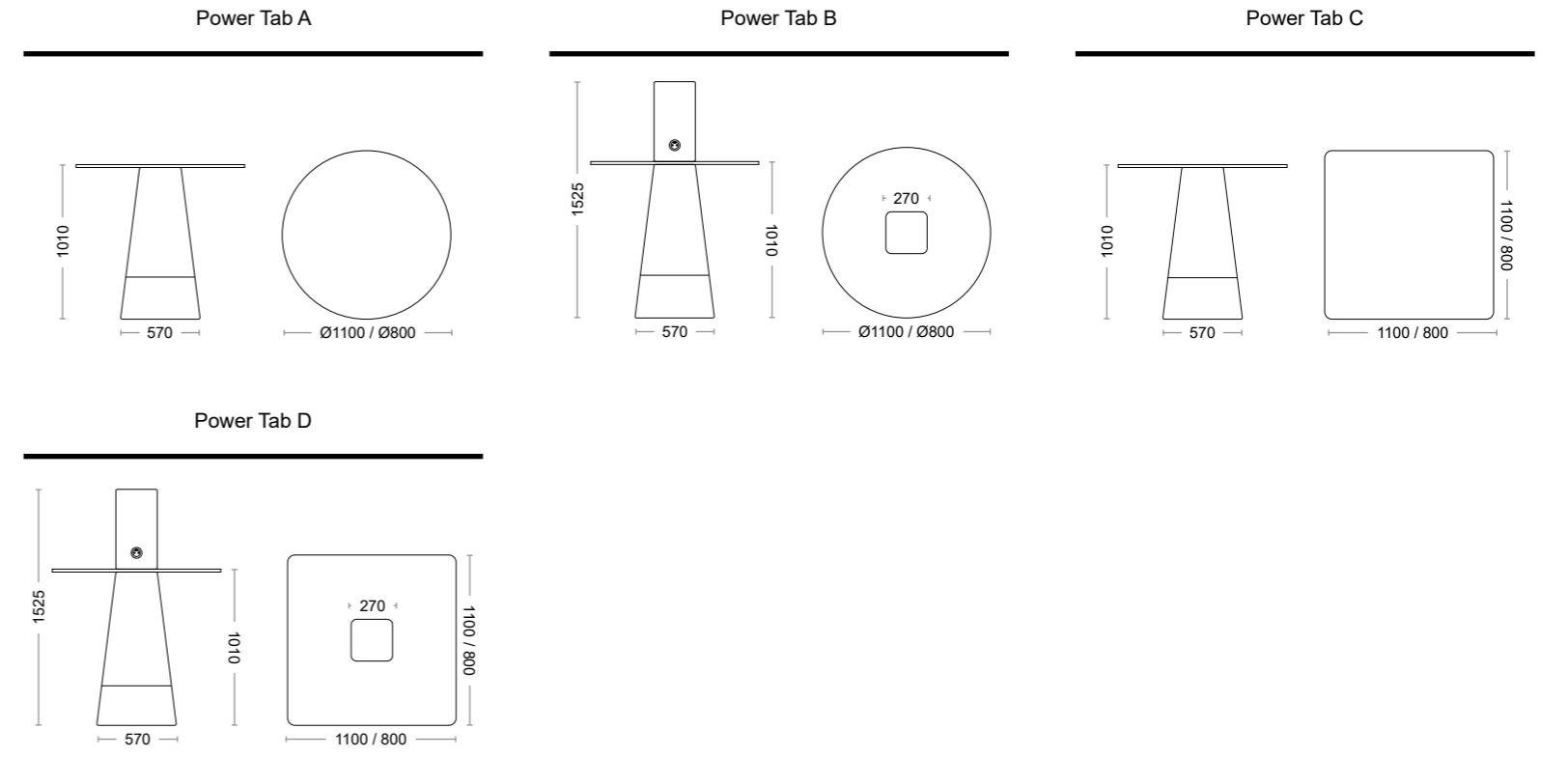



Dados Técnicos | Technical Data | Dados Tecnicos | Données Techniques

QUADRATA

Desenvolvidas especialmente para a poltrona Quadrata, a linha de mesas Quadrata define-se como um sistema de produto onde é utilizada sempre a mesma estrutura, variando na forma, dimensões e materiais do tampo.

Desarrollada especialmente para el sillón Quadrata, la línea de mesas Quadrata se define como un sistema de productos donde se utiliza siempre la misma estructura, variando en forma, dimensiones y materiales de la tapa.

Designed especially for the Quadrata armchair, the Quadrata table collection is defined as a product system where the same structure is always used, varying in the shape, dimensions and materials of the table top.

Conçu spécialement pour le fauteuil Quadrata, la table Quadrata est définie comme un système de la même structure est toujours utilisée, variant dans la forme, les dimensions et les matériaux du dessus de table.

Quadrata

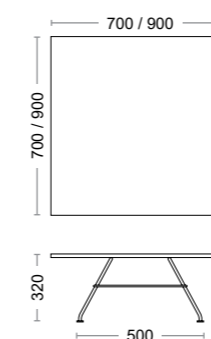

Quadrata

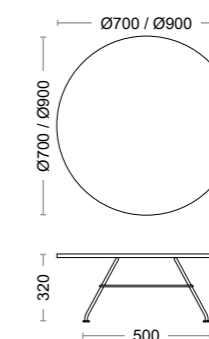

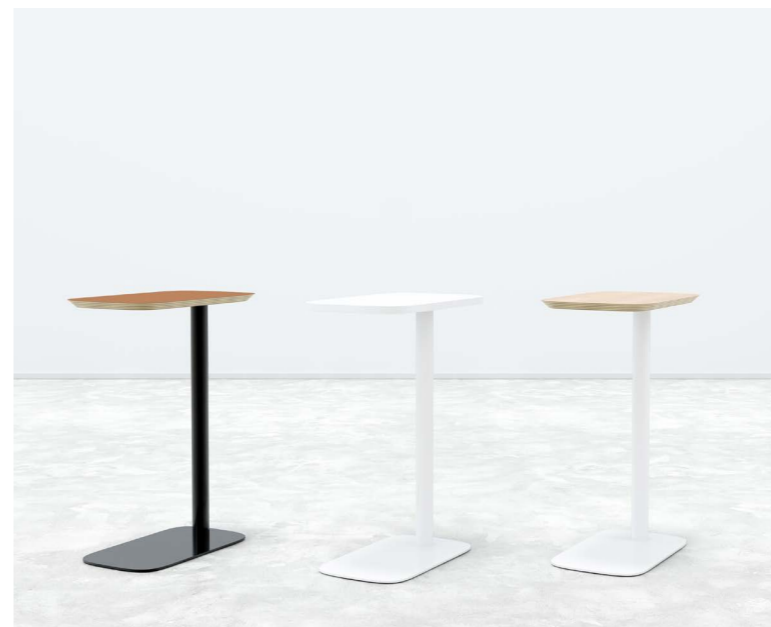

Dados Técnicos | Technical Data | Dados Tecnicos | Données Techniques

RADIUS

Através de um design orientado para a agilidade e flexibilidade, a Radius resume-se a uma mesa de apoio apta para as novas tendências do mobiliário de escritório. Com uma forma que permite uma simbiose entre outros produtos, é capaz de converter sofás em pequenas zonas de trabalho.

Gracias a su diseño orientado a la agilidad y la flexibilidad, Radius se resume a una mesa auxiliar adecuada para las nuevas tendencias de muebles de oficina. Con una forma que permite la simbiosis entre otros productos, puede convertir sofás en pequeñas áreas de trabajo.

Through its agility and flexibility-oriented design, Radius boils down to a side table fit for new office furniture trends. With a shape that allows symbiosis among other products, it is able to convert sofas into small work areas.

Par son agilité et son design axé sur la flexibilité, Radius se réduit à une table d'appui adaptée aux nouvelles tendances en matière de mobilier de bureau. Avec une forme qui permet la symbiose entre d'autres produits, il est capable de convertir des canapés en petites zones de travail.

Radius

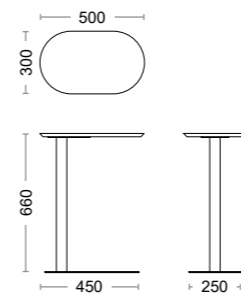



SHARP

Porque uma mesa de centro não tem que ser apenas uma mesa de centro, podendo tornar-se num sistema de produto. A Sharp nasce precisamente desse pressuposto, resultando em diferentes tipologias que podem ser incorporadas em várias situações.

Debido a que una mesa de café no tiene que ser solo una mesa de café, puede convertirse en un sistema de productos. Sharp nace precisamente de esta suposición, lo que resulta en diferentes tipologias que se pueden incorporar en diversas situaciones.

Because a coffee table doesn't have to be just a coffee table, it can become a product system. Sharp is born precisely from this assumption, resulting in different typologies that can be incorporated in various situations.

Parce qu'une table basse ne doit pas uniquement être une table basse, elle peut devenir un système de produit. Sharp est né précisément de cette hypothèse, donnant lieu à différentes typologies pouvant être incorporées dans diverses situations.

Dados Técnicos | Technical Data | Dados Tecnicos | Données Techniques

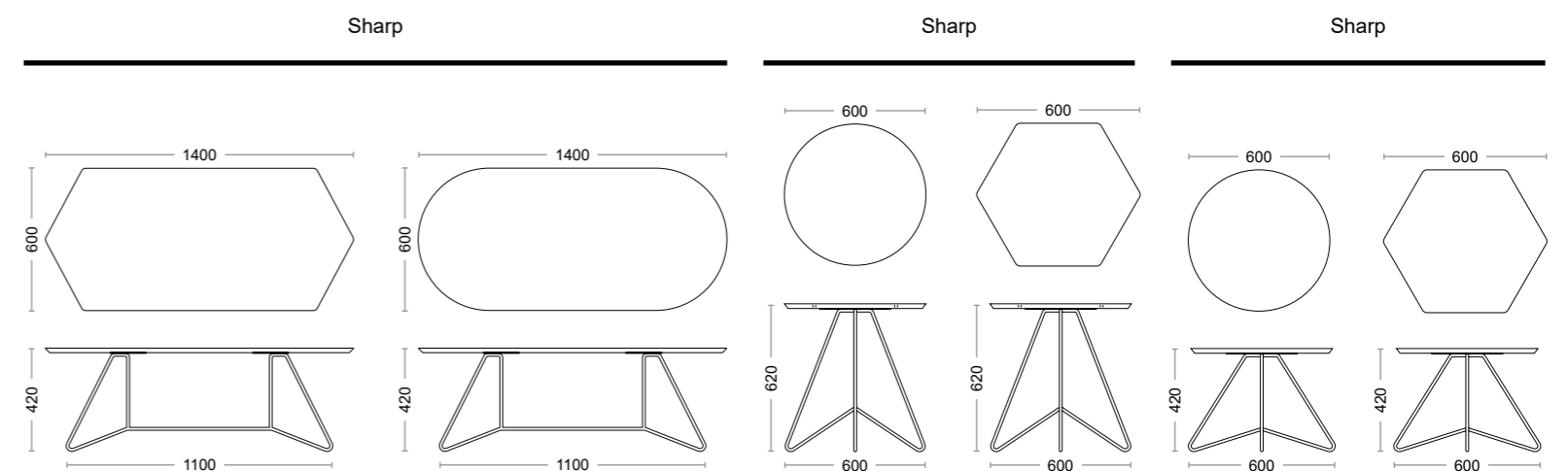



TAB20

Com uma estética irreverente e bastante moderna, o modelo TAB_20 transforma-se num produto ideal para espaços de trabalho ágeis por várias razões. Por um lado a mesa possui rodízios o que permite a sua deslocação de forma simples, por outro lado por ter um tampo rebatível a 90 graus.

Con una estética irreverente y muy moderna, el modelo TAB_20 se convierte en un producto ideal para espacios de trabajo ágiles por varios motivos. Por un lado, la mesa cuenta con ruedas que permiten moverla de forma sencilla, por otro lado porque cuenta con una tapa abatible a 90 grado.

With an irreverent and very modern aesthetic, the TAB_20 model becomes an ideal product for agile workspaces for several reasons. On the one hand, the table has casters which allow it to be moved in a simple way, on the other hand because it has a 90-degree folding top.

Avec une esthétique irrévérrencieuse et très moderne, le modèle TAB_20 devient un produit idéal pour les espaces de travail agiles pour plusieurs raisons. D'une part, la table a des roulettes qui lui permettent d'être déplacée de manière simple, d'autre part parce qu'elle dispose d'un plateau rabattable à 90 degrés.



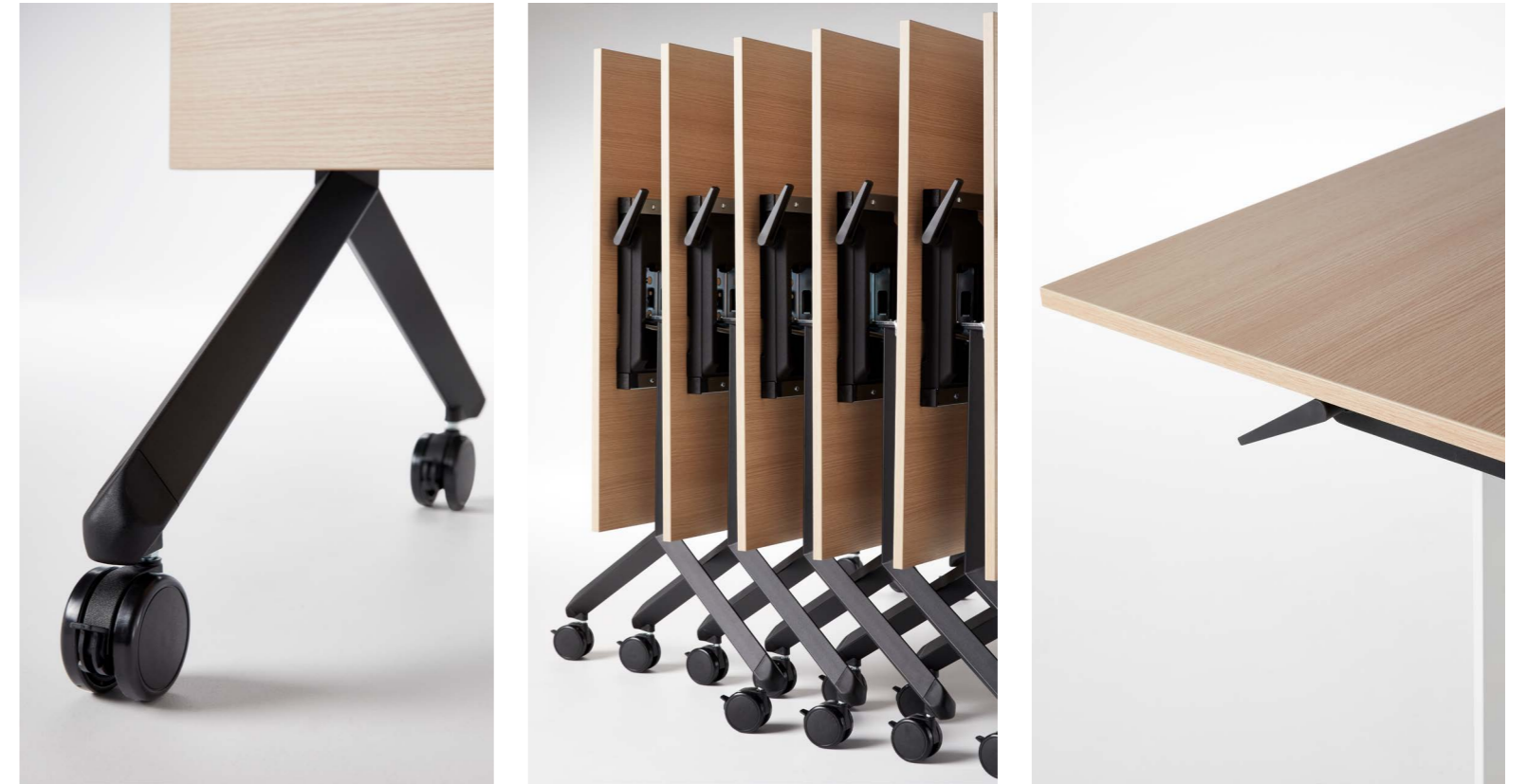

Dados Técnicos | Technical Data | Dados Tecnicos | Données Techniques



Tab20

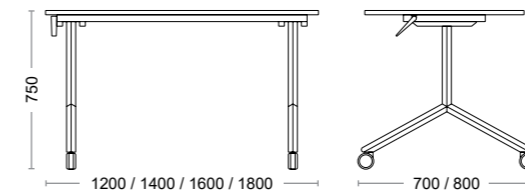



GRID

A coleção Grid é um sistema modular de aparadores com construção em madeira. Permite criar várias soluções através de layouts com base numa construção em grelha. O produto permite combinar tecido com Valchromat e madeira natural.

La colección Grid es un sistema de aparadores modulares fabricados en madera. Puede crear fácilmente varias soluciones utilizando diseños basados en una construcción de cuadrícula. La colección permite combinar tejidos con Valchromat y madera natural.

The Grid collection is a modular sideboard system manufactured in wood construction. You can easily create multiple solutions by using layouts based on a grid construction. The collection allows you to combine fabrics with Valchromat and natural wood.

La collection Grid est un système de buffet modulaire fabriqué en bois. Vous pouvez facilement créer plusieurs solutions en utilisant des mises en page basées sur une construction en grille. La collection vous permet de combiner des tissus avec du Valchromat et du bois naturel.





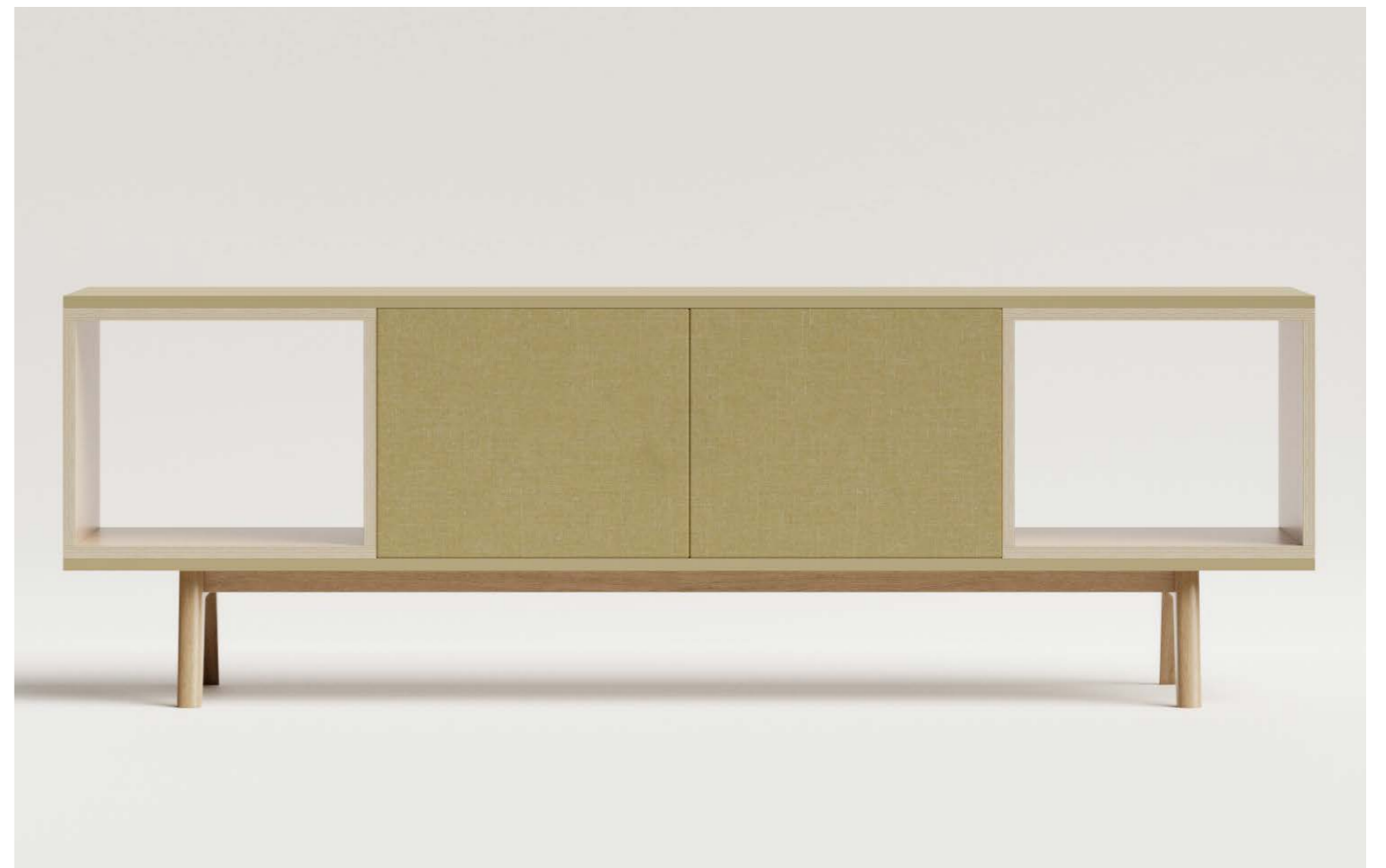







Grid - Sideboard

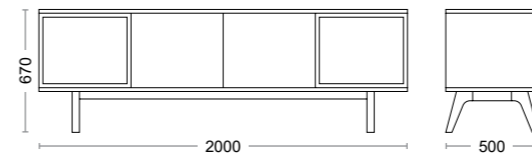

Grid - Sideboard

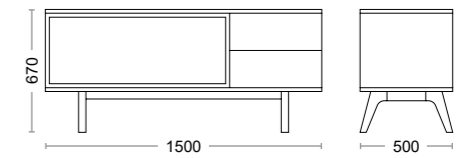

Grid - Sideboard

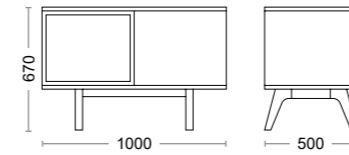

Grid - High Table

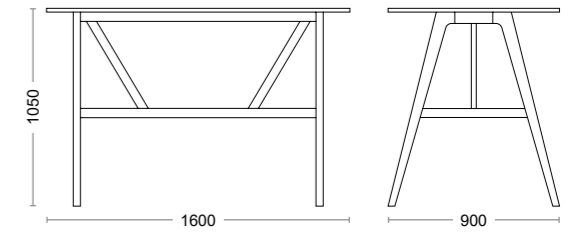



TAB60

Alternar a postura durante o horário de trabalho é algo considerado fundamental para uma maior concentração e produtividade. Com a TAB_60 esta variação torna-se ainda mais fácil e fluida permitindo estabelecer duas posturas de trabalho na mesma secretária através de um sistema de elevação eletrificado.

La postura alterna durante las horas de trabajo se considera esencial para una mayor concentración y productividad. Con TAB_60 esta variación se vuelve aún más fácil y fluida, permitiendo establecer dos posturas de trabajo en el mismo escritorio a través de un sistema de elevación electrificado.

Alternating posture during working hours is considered essential for greater concentration and productivity. With the TAB_60 this variation becomes even easier and more fluid, allowing two working postures to be established on the same desk through an electrified lifting system.

L'alternance de posture pendant les heures de travail est considérée comme essentielle pour une concentration et une productivité accrues. Avec le TAB_60 cette variante devient encore plus simple et fluide, permettant d'établir deux postures de travail sur le même bureau grâce à un système de levage électrifié.





Tab60

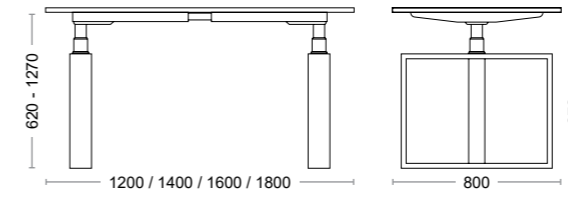

Tab60

